



SECHE-LINGE

MANUEL DE SERVICE

BANDEAU F1 - POMPE A CHALEUR



CONTENTS

- 1. OVERVIEW AND WORKING PRINCIPLE.....4
 - 1.2. Working Principle:.....4
- 2. TECHNICAL SPECIFICATIONS.....5
- 3. INSTALLATION.....5
 - 3.1. Issues that should be informed to customer5
- 4. CONTROL PANEL AND PROGRAM SELECTION TABLE.....6
 - 4.1. Control Panel6
 - 4.2. Program List6
- 5. FAILURE MODES AND SERVICE AUTOTEST8
 - 5.1. Failure Modes and Warning Leds.....9
 - 5.2. Service Auto Test Steps10
- 6. DISASSEMBLY.....11
 - 6.1 Top Plate.....11
 - 6.2. Control Panel12
 - 6.3. Electronic Card15
 - 6.4. Side Panel18
 - 6.5. Supply Cable20
 - 6.6. Emi Filter.....21
 - 6.7. Rear Cover22
 - 6.8.Pump23
 - 6.9.Process Fan25
 - 6.10. Rear Panel.....26
 - 6.11.Rear Isolation Group28
 - 6.12. Rear Bearing Group29
 - 6.13.Water Tank Housing.....30
 - 6.14.Drum.....31
 - 6.15. Motor.....32
 - 6.16.Capacitors34
 - 6.16.Belt35
 - 6.18. Humidity Sensor36
 - 6.19. Door latch37
 - 6.20. Plinth38
 - 6.21. Cooling Fan39

6.22. Plinth Cover.....	40
6.23. Door.....	41
6.24. Drum Bearing Wheel.....	42
6.25. Drumlight.....	43
6.26. Front Panel.....	44
6.27. Door NTC.....	45
6.28. Side Bracket.....	46
6.29. Front Shield.....	47
6.30. Front Isolation Foam.....	48
6.31. Cable Group.....	49
7. 7. COMPONENT SPECIFICATIONS AND MEASUREMENTS.....	51
7.1. Motor.....	51
7.1.1. Motor Measurements.....	52
7.2. Pump.....	53
7.2.1 Pump Measurements.....	54
7.3. Electronic Card.....	55
7.4. Door/Compressor NTC Sensor.....	55
7.4.1. Door NTC Sensor Measurements.....	56
7.5. Compressor.....	56
7.5.1. Compressor Measurements.....	58
7.6. Door Latch.....	59
7.6.1 Door Latch Measurements.....	59
7.7. Humidity Sensor.....	60
7.7.1 Humidity Sensor Measurements.....	60
7.8. Cooling Fan.....	61
7.8.1. Cooling Fan Measurements.....	62
7.9. Drumlight.....	62
8. TROUBLESHOOTING.....	63

1. OVERVIEW AND WORKING PRINCIPLE

1. Top Plate
2. Control Panel
3. Loading Door
4. Plinth
5. Plinth opening slot
6. Ventilation grills
7. Adjustable feet
8. Plinth cover
9. Type plate
10. Lint filter
11. Drawer Cover

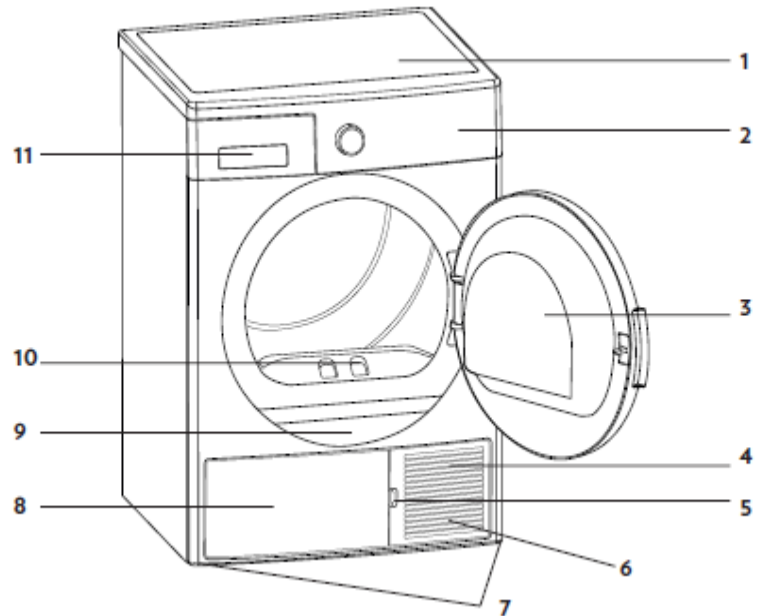

1.2. Working Principle:

In the heat pump dryer machine, heated air is sent to the wet laundry in the drum from the heater side of the coil which called by condenser. The humidity of the laundry is taken and reaches the cold side of the coil which called by evaporator via filter. With a compressor, refrigerant is passed through inside of the tubes of coils both condenser and evaporator. A capillary causes resistance against to refrigerant flow. By this way, the evaporator surface is cooled and condenser surface is heated. The hot and humid air from the drum is reached cold evaporator surface and the humidity on it is left as water. The condensing water in the evaporator is pumped to the water tank by the pump.

	HP F1 PANEL	CUSTOMER SUPPORT
	SERVICE MANUAL	

2. TECHNICAL SPECIFICATIONS

Manufacturer	Vestel White Goods	
Capacity (max)	7 kg	8 kg / 9kg
Height	Min: 845mm Max: 855 mm	Min: 845mm Max: 855 mm
Depth	563 mm	609 mm
Width	596 mm	596 mm
Net weight (with plastic door)	44,8 kg	46,8 kg
Net weight (with glass door)	46,8 kg	48,8 kg
Voltage	220-240 V	
Working Temp.	+5°C - +35°C	
Power	1000 W	

3. INSTALLATION

3.1. Issues that should be informed to customer

1. Drying machine must be grounded.
2. Lint filter must be cleaned after each use
3. Water tank must be unloaded after each use
4. Even if the heat exchanger cleaning warning les is not on : clean the heat exchanger after every 30 drying processes or once a month
5. The amount of laundry should be appropriate to program.
6. Use this product only for laundry with a label that indicates it is suitable for drying.
7. Children should not play with appliance.
8. This product contains environmental friendly but flammable **R290** gas. Keep open flame and fire sources away from the product.
9. Ventilation grills should not be closed.
10. The service life time of tumble dryer is 10 years.
11. Adjustable feet should not be removed.
12. There should not be lockable or sliding door in the installation area
13. Never spray or pour water onto the dryer to wash it. There is a risk of electric shock.

Please ensure that customer reads the user manual



1. Check the environmental conditions. **(Voltage, current etc.)**
2. Ensure that product is used correctly
3. Check the machine with **Service Auto Test**. If the system displays failure code, find the corresponding code in the failure code list then act according to this.
4. Check the electronic connections

4. CONTROL PANEL AND PROGRAM SELECTION TABLE

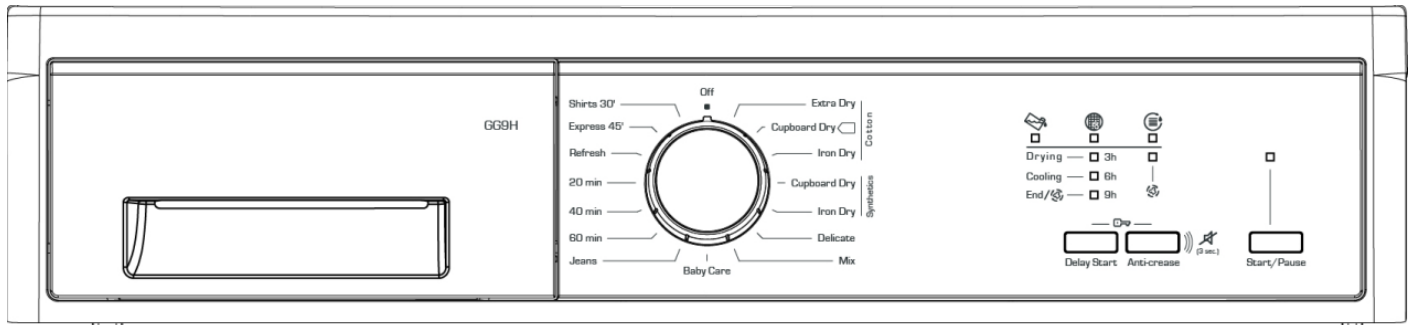

4.1. Control Panel



Display Symbols

Water tank warning indicator	
Lint filter cleaning warning indicator	
Heat exchanger cleaning warning indicator	

Drying Stages Indicator

Drying	
Cooling	
End	

4.2. Program List

KNOB POSITION	PROGRAM
1	Cotton Extra Dry
2	Cotton Cupboard Dry
3	Cotton Iron Dry
4	Synthetics Cupboard Dry
5	Synthetics Iron Dry
6	Delicate
7	Mix
8	Baby Care
9	Jeans
10	60 min
11	40 min
12	20 min
13	Refresh
14	Express 45'
15	Shirts 30'
16	OFF

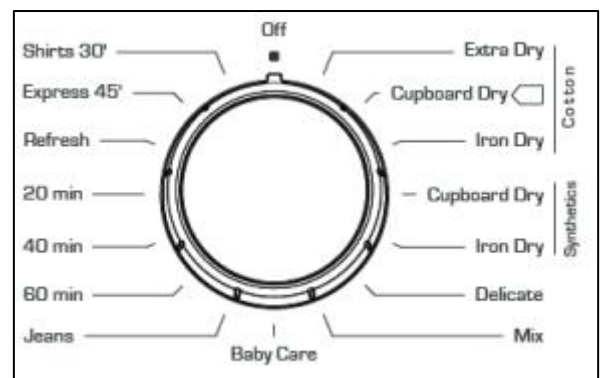

***The machine has humidity sensor that detects whether the laundry dry or not. At the programs which work with humidity sensor laundry does not dry in fixed time. Duration is constantly updates according to humidity data taking from laundry.

*****Time Drying Program: 60min /40min / 20min** Humidity sensor is deactivated. The program ends when the time is up, without checking the humidity of the laundry.

*****Express 45'/ Shirts 30'** : Humidity sensor is activated. The program time may extend, if the customer use different laundry according to the load in the program description.

Express 45': 2 kg of cotton shirts spun at a high speed in the washing machine are dried in 45 minutes.

Shirts 30': 2 to 3 shirts are ready for to be ironed in 30 minutes.

*****Delicate:** Delicate fabrics are dried for a longer time at a low temperature.

4.3. Children's Safety

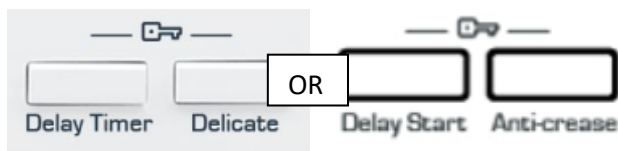

There is a child lock option to avoid pressed during the program changes in the program flow when keys are pressed during the program.

There is 2 panels version which is Delicate or Anti Crease .To activate child lock;

If it is "Anti Crease" panel, press and hold "Delay Start" and "Anti-Crease" keys simultaneously for 3 seconds.

If it is "Delicate" panel, press and hold "Delay Start" and "Delicate" keys simultaneously for 3 seconds

When the child lock is active, all keys will be deactivated. Child lock will be deactivated automatically at the end of the program. When activating/deactivating the child lock, the leds of the "Anti-Crease" and "Delicate Drying" options will flash and an audible warning will be heard.





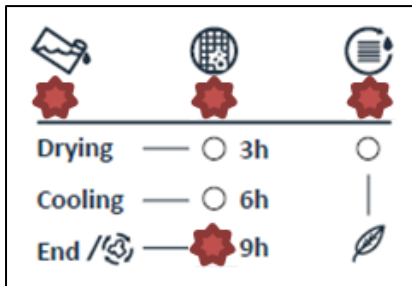
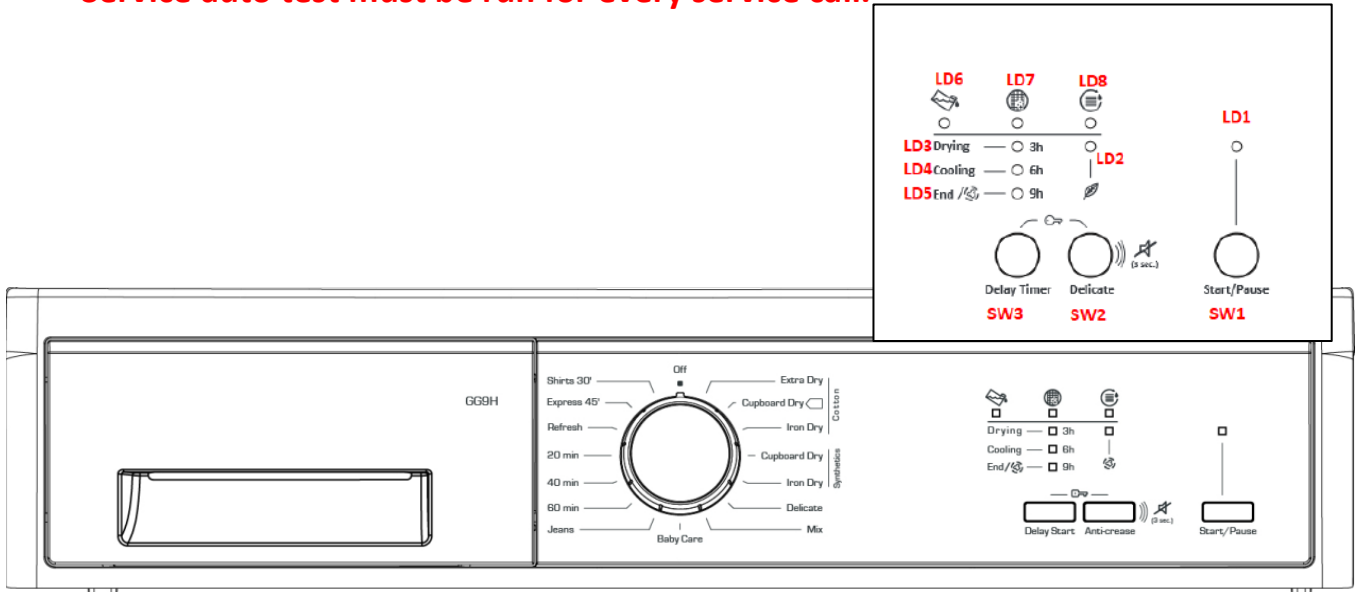























5. FAILURE MODES AND SERVICE AUTOTEST

*****Service auto test must be run for every service call.**



The case in the photo don't show us a failure code. (If it is don't blinking) Normally, when the drying program ends, the filter, water tank and end led are flashing. In addition, heater exchanger cleaning warning led is on every 30 cycles.

5.1. Failure Modes and Warning Leds

F1 HEAT PUMP MODEL ERROR CODES		
ERROR CODE	REASON	
E03  Drying — ○ 3h — ○ Cooling — ○ 6h — End /  — ○ 9h — 	Aquaswitch connector is disconnected	
E04  Drying —  3h — ○ Cooling —  6h — End /  — ○ 9h — 	Compressor connector is disconnected	
E05  Drying —  3h — ○ Cooling — ○ 6h — End /  —  9h — 	Compressor NTC connector is disconnected	
E06  Drying — ○ 3h —   Cooling — ○ 6h — End /  — ○ 9h — 	Door NTC connector is disconnected	
E07  Drying — ○ 3h — ○ Cooling —  6h — End /  —  9h — 	Motor connector is disconnected, motor is locked	
E08  Drying —  3h — ○ Cooling —  6h — End /  —  9h — 	Voltage fluctuation	

Notes For Service autotest:

*Service can not pass the current step before completing the minimum duration

*When minimum duration for each step (5 sec) is completed, filter led makes **slow blink** to indicate that service can pass the next step

*For error codes, leds must make **fast blink**

*****Power analyzer must be plugged and machine is connected to this analyzer.**

5.2. Service Auto Test Steps

STEPS	Control		Possible Errors
The Routine to Enter Servis Autotest	<p>While pushing SW2 button for 5 sec, position knob to Program 1. Then press Start/Pause button. Machine enters to service autotest.</p> <p>F2: All warning leds makes fast blink for 2 sec and then becomes fix off.</p> <p>Machine shows the last error saved by machine. When knob positioned to program 2, control steps starts.</p>		
Step 2 (Knob Position 2)	Dryer check Aquaswitch, if aquaswitch ON go to next step (pump activation), if aquaswitch OFF give water tank full error	LD6	<ul style="list-style-type: none"> *Aquaswitch connector is taken out *Aquaswitch connector is short circuit *Styrofoam is broken or not
Step 3 (Knob Position 3)	Pump is on	-	<p>Service must pour water to pump reservoir and check whether water is pumped to tank.</p> <p>If water is not pumped to water tank;</p> <ul style="list-style-type: none"> *Pump connector is taken out
Step 4 (Knob Position 4)	Motor CCW (Tumble CW)-Motor stops	-	<p>Service must check whether tumble is moving to CW.</p> <p>If not;</p> <ul style="list-style-type: none"> *Motor connector is taken out *Motor might be locked *Motor belt might be dislocated
Step 5 (Knob Position 5)	Motor CW (Tumble CCW) -Motor stops	-	<p>Service must check whether tumble is moving to CCW</p> <ul style="list-style-type: none"> *If tumble is moving to CW again, then motor relay short circuit CCW
Step 6 (Knob Position 6)	Check Compressor NTC if heater NTC T=255	LD3 LD5	*Compressor NTC connector is taken out or short circuit
Step 7 (Knob Position 7)	Check Door NTC if heater NTC T=255	LD2 LD3	*Door NTC connector is taken out or short circuit
Step 8 (Knob Position 8)	Compressor OFF- Motor CCW (Tumble CW) OFF- Cooling fan ON	-	Service must check power of at the home voltage and fan will be controlled manually by technical service.
Step 9 (Knob Position 9)	Compressor ON- Motor CCW (Tumble CW) Motor OFF	-	Service must check power of at the home voltage.
Step 10 (Knob Position 10)	Check conductivity sensor when door is opened and motor is off	LD2 LD5	<p>Service puts his hand on the humidity sensor plates and software checks sensor data</p> <ul style="list-style-type: none"> *If sensor data=0, humidity sensor connector is taken out

6. DISASSEMBLY

6.1 Top Plate

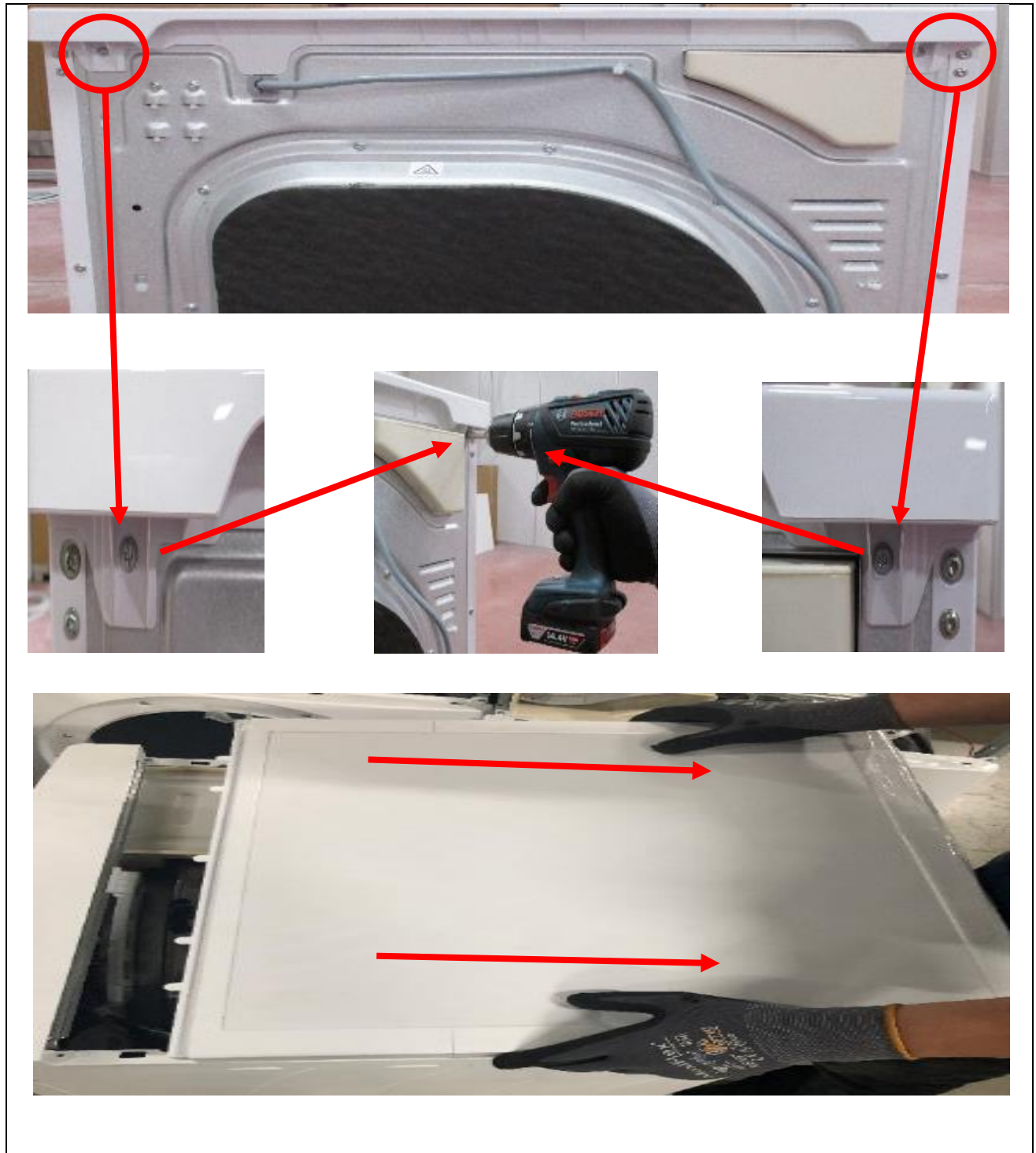

1. Remove two screws that fix the top plate at the back.
2. Remove by pulling the top plate to yourself.

6.2. Control Panel

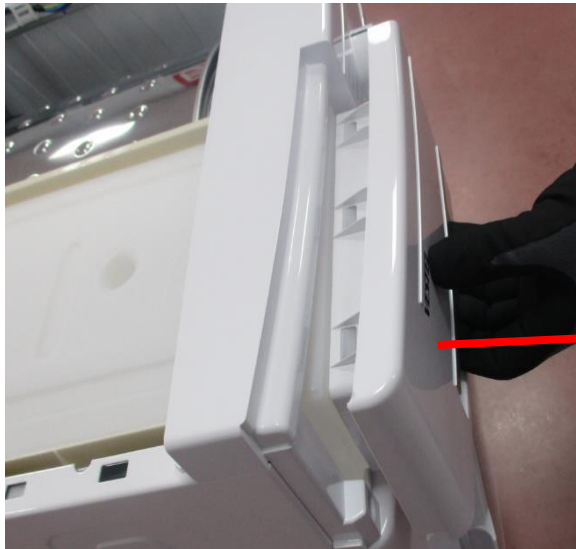
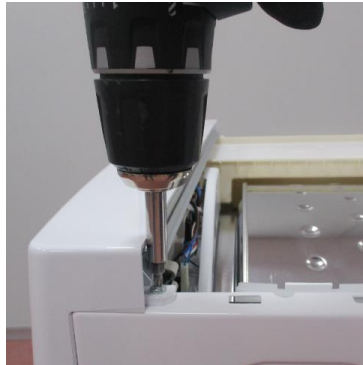
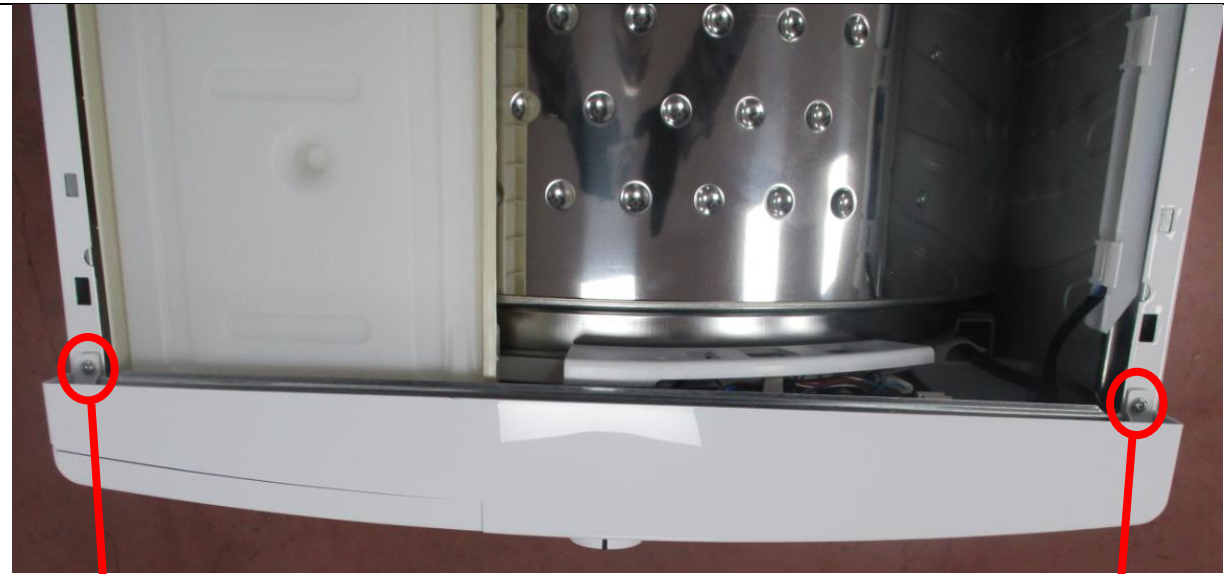

1. Remove 2 screws from the top
2. After the water tank removed, the plastic screw in the center of the control panel should be removed.

6.2. Control Panel

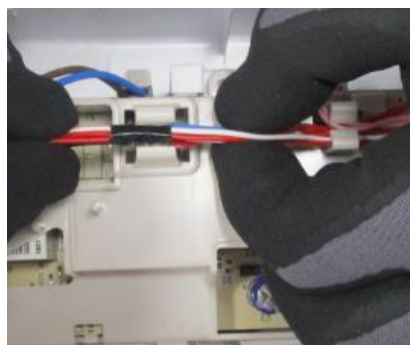
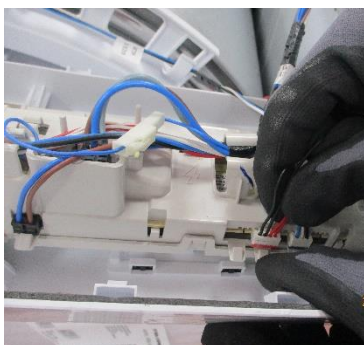

1. After removing the screws on the control panel, the control panel is removed as shown in the photo from the upper support bracket.
2. The cables on the control panel are carefully removed from the cable paths.

6.2. Control Panel

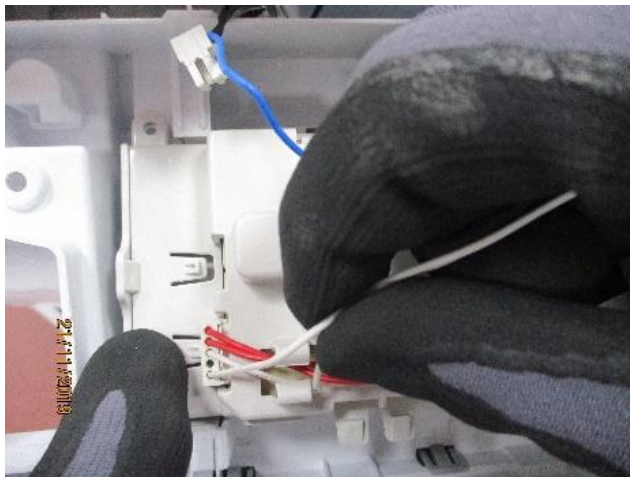
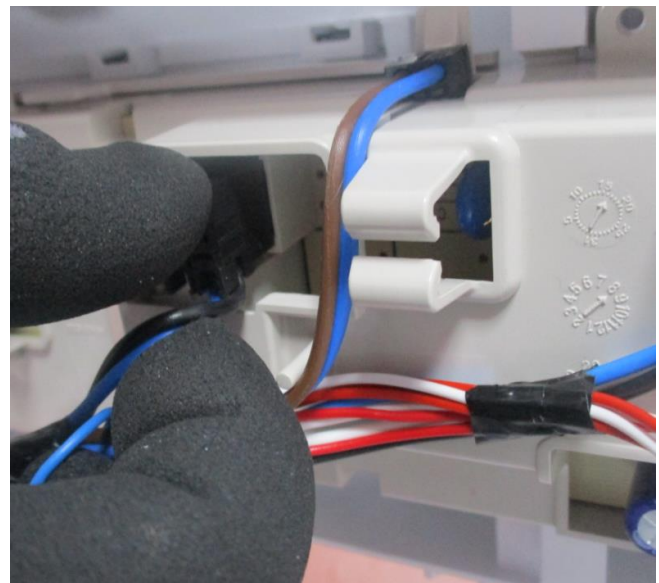

1. All sockets which is connected with electronic card must be removed carefully as shown in the photo.

6.3. Electronic Card

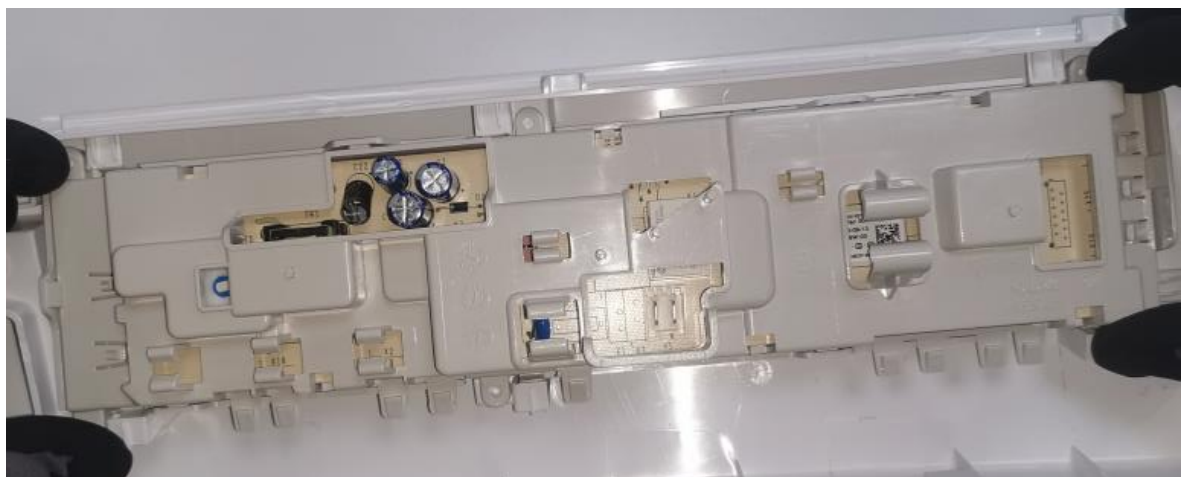

1. To remove the electronic card box (PCB box) from the control panel, it is necessary to remove 6 tabs. As shown in the photo, you can take off the snap fits with thin screwdriver.
2. The PCB box is separated from the control panel.

6.3. Electronic Card



1. Separate electronic card cover from box by opening the snap fits as shown in the photo. There is selection buttons on the cover.

6.3. Electronic Card

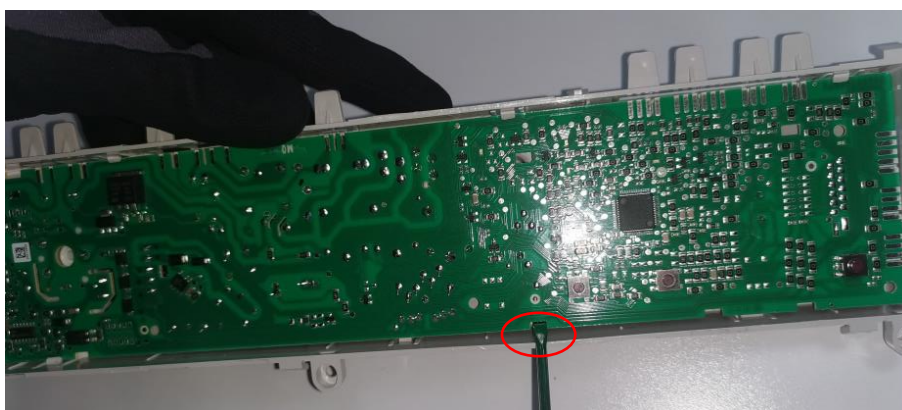
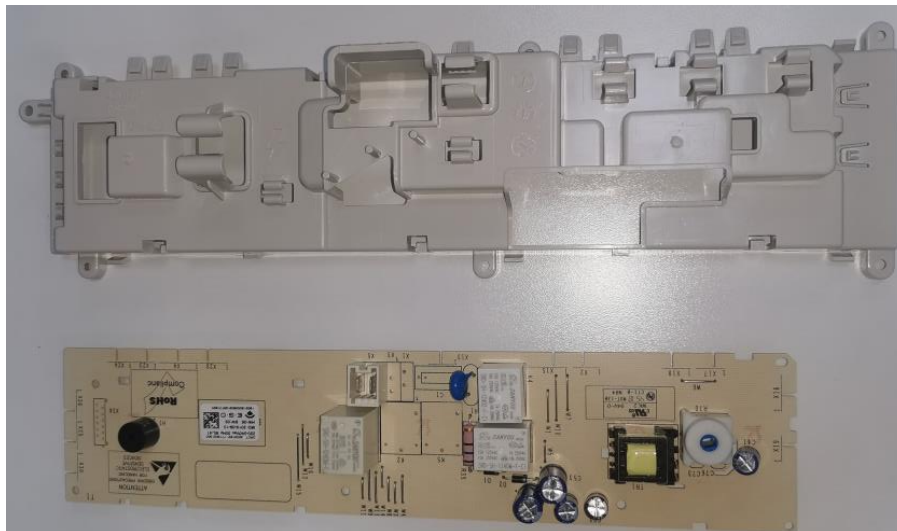

1. The electronic card inside is removed from the nails.

6.4. Side Panel



1. Remove 10 screws on side panels

6.4. Side Panel

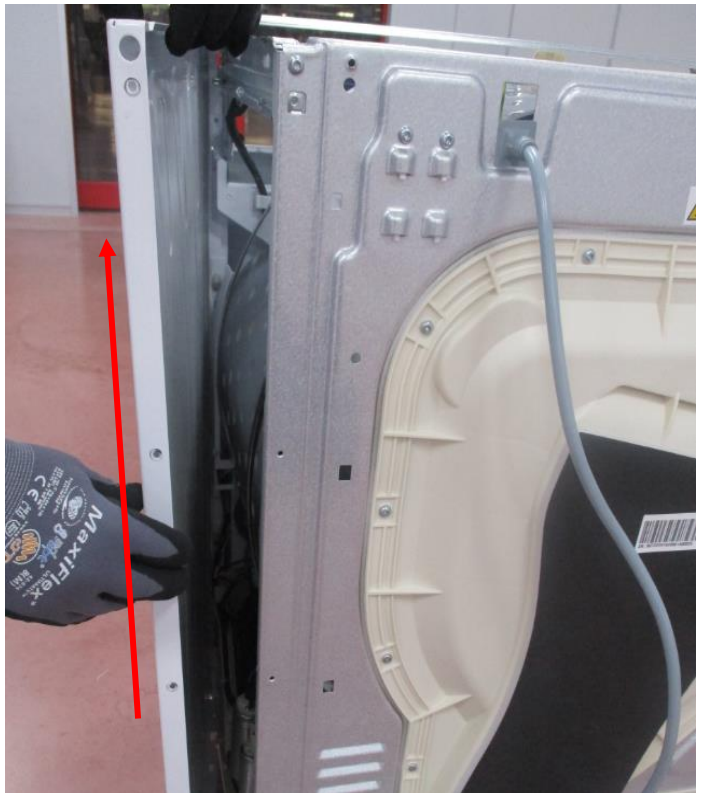
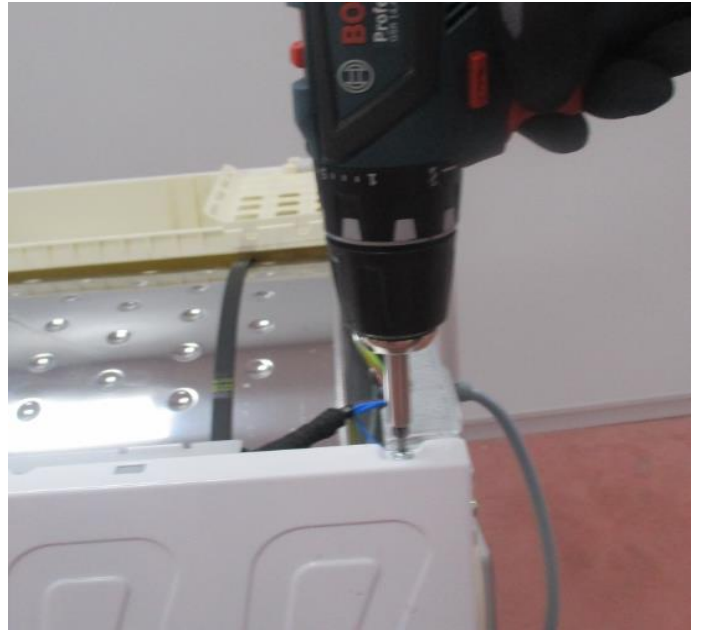

2. Remove 2 screws from front
3. It should not be forgotten to take bottom screw (2 screws)
4. Remove the side plate which is pulled out screws , by pushing up

6.5. Supply Cable

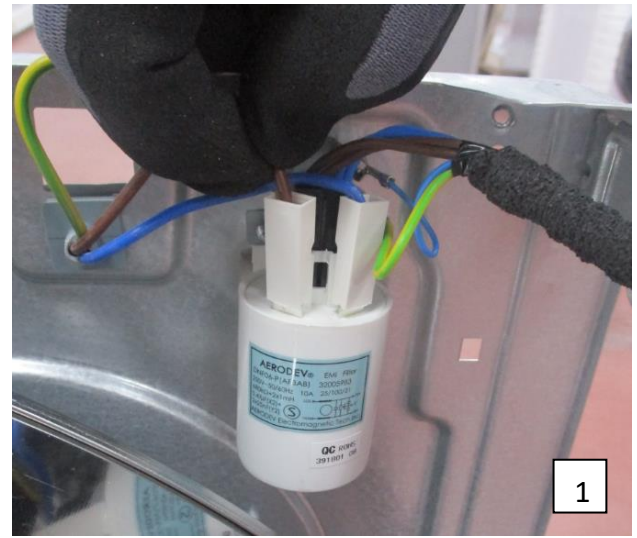

1. Remove the supply cable brown and blue cable socket.
2. Remove the terminals with tool as shown in the photo
3. Remove supply cord by pushing up

6.6. Emi Filter

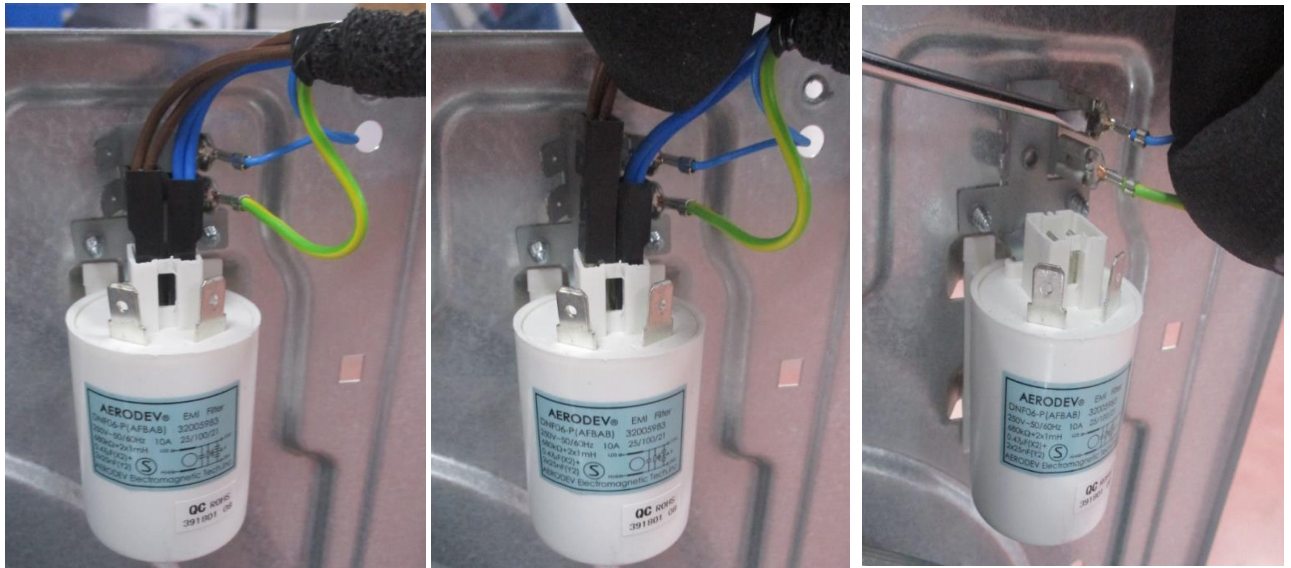

1. Remove EMI filter sockets
2. Remove the terminals with tool as shown in the photo
3. Remove the EMI filter which is fixed with 2 screws to the rear panel

6.7. Rear Cover



1. Remove all screws shown in the photo.

6.8.Pump

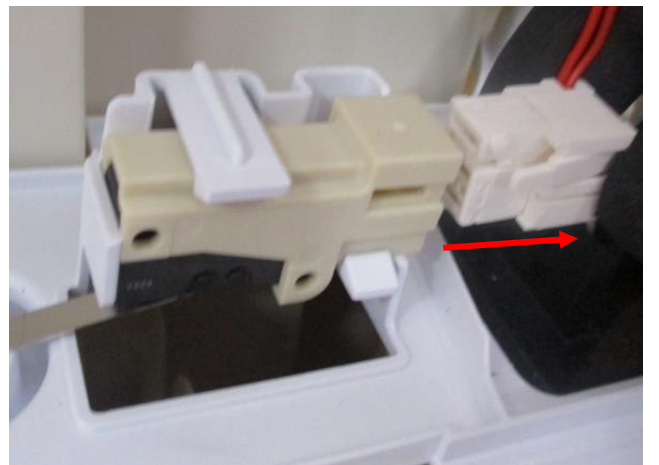
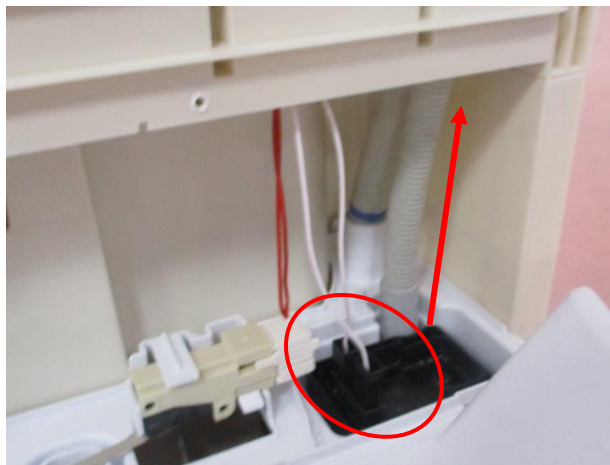

1. Remove the screw on pump cover
2. After opening the pump holder plastic cover, Remove 2 hoses that is connected with pump.
3. Remove aqua switch and pump socket.
4. Remove the pump holder plastic from basement plastic as shown in the photo

6.8.Pump



5. Push the pump from plastic.
6. There is a float in the pump housing as shown in the photo.

6.9.Process Fan



1. Hold the fan as shown in the photo.
2. First remove washer and nut then remove the process fan.

6.10. Rear Panel

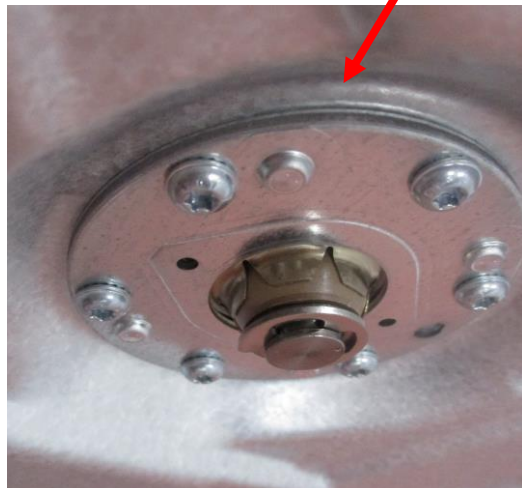
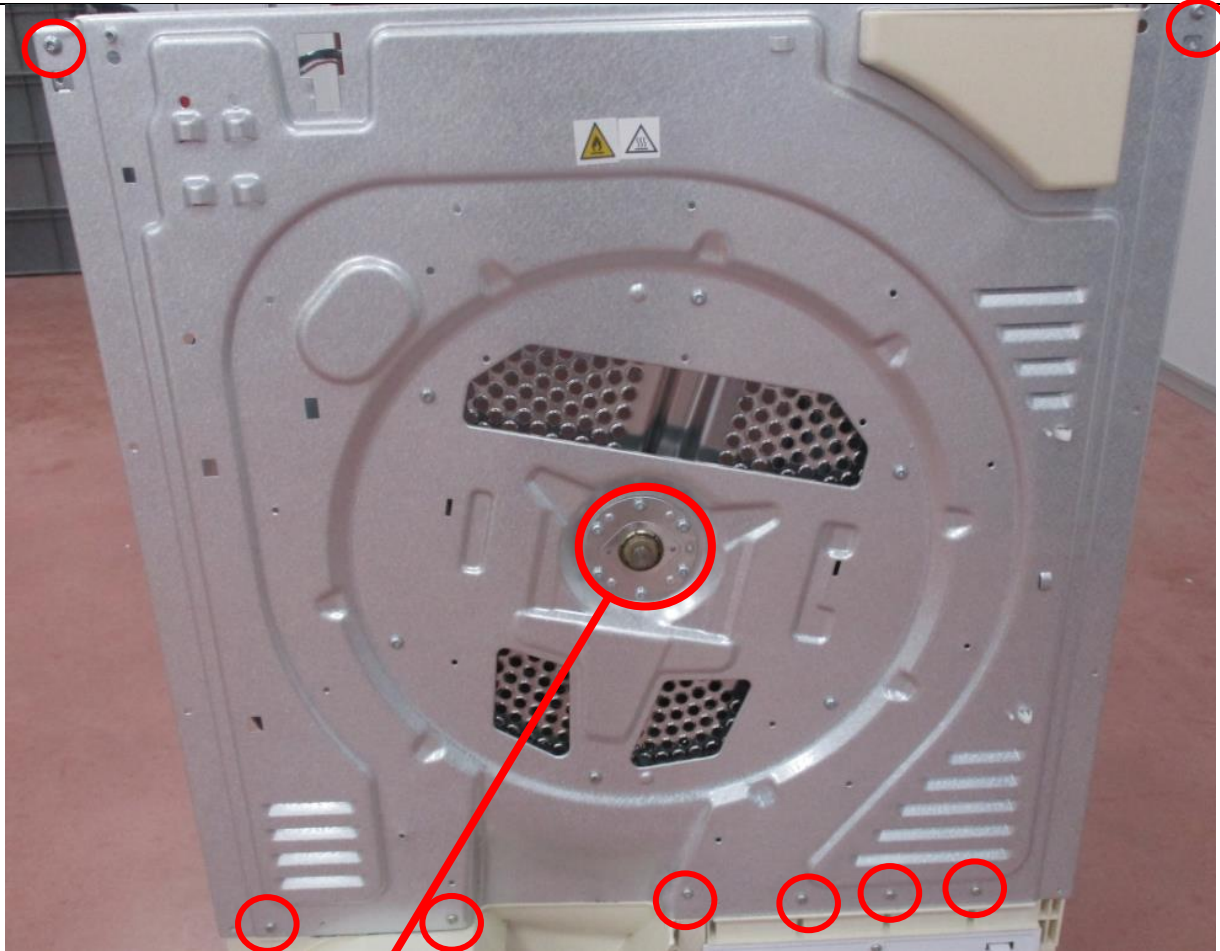

1. Remove segment on rear panel.
2. Remove 8 screws from panel

6.10. Rear Panel

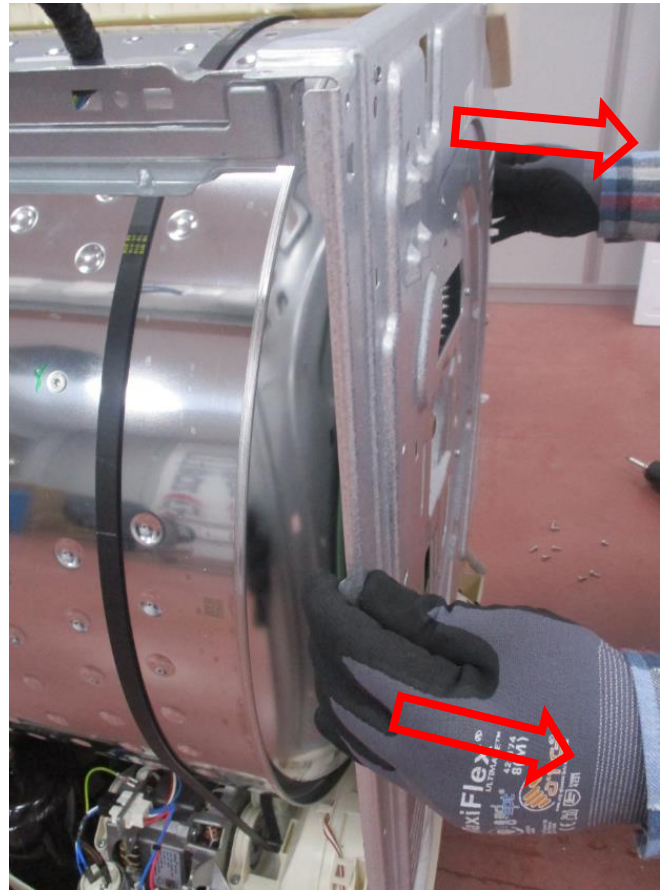
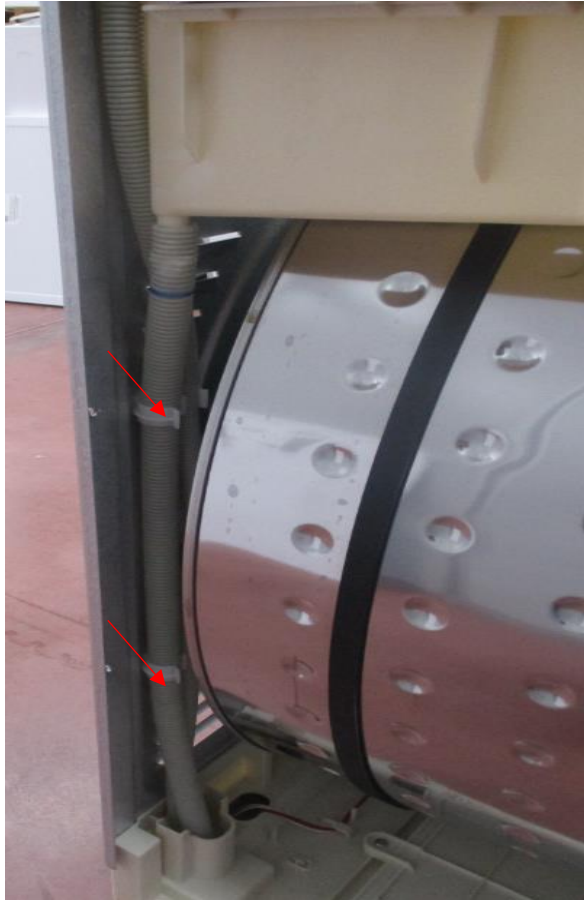

1. Remove hoses from rear panel
2. Remove the rear panel by pulling to yourself.

6.11.Rear Isolation Group

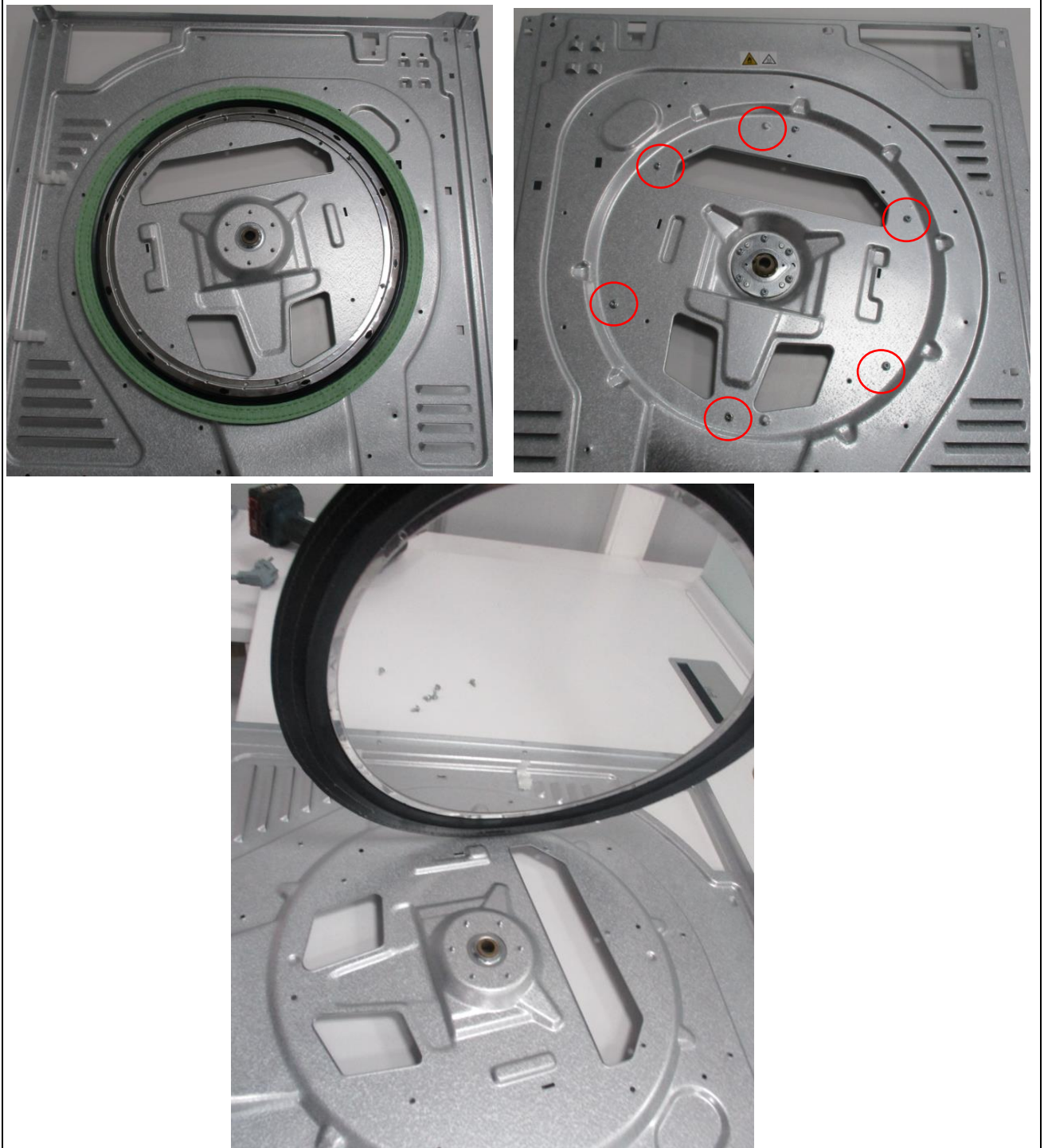

1. For disassembling the rear Isolation group on rear panel, screws are shown in the photo should be removed.

6.12. Rear Bearing Group



1. For disassembling the rear bearing group on rear panel, screws are shown in the photo should be removed.

6.13. Water Tank Housing



1. Remove 2 hoses from water tank housing.
2. Remove the water tank housing clips.
3. The water tank housing is removed as in the photo.

6.14.Drum

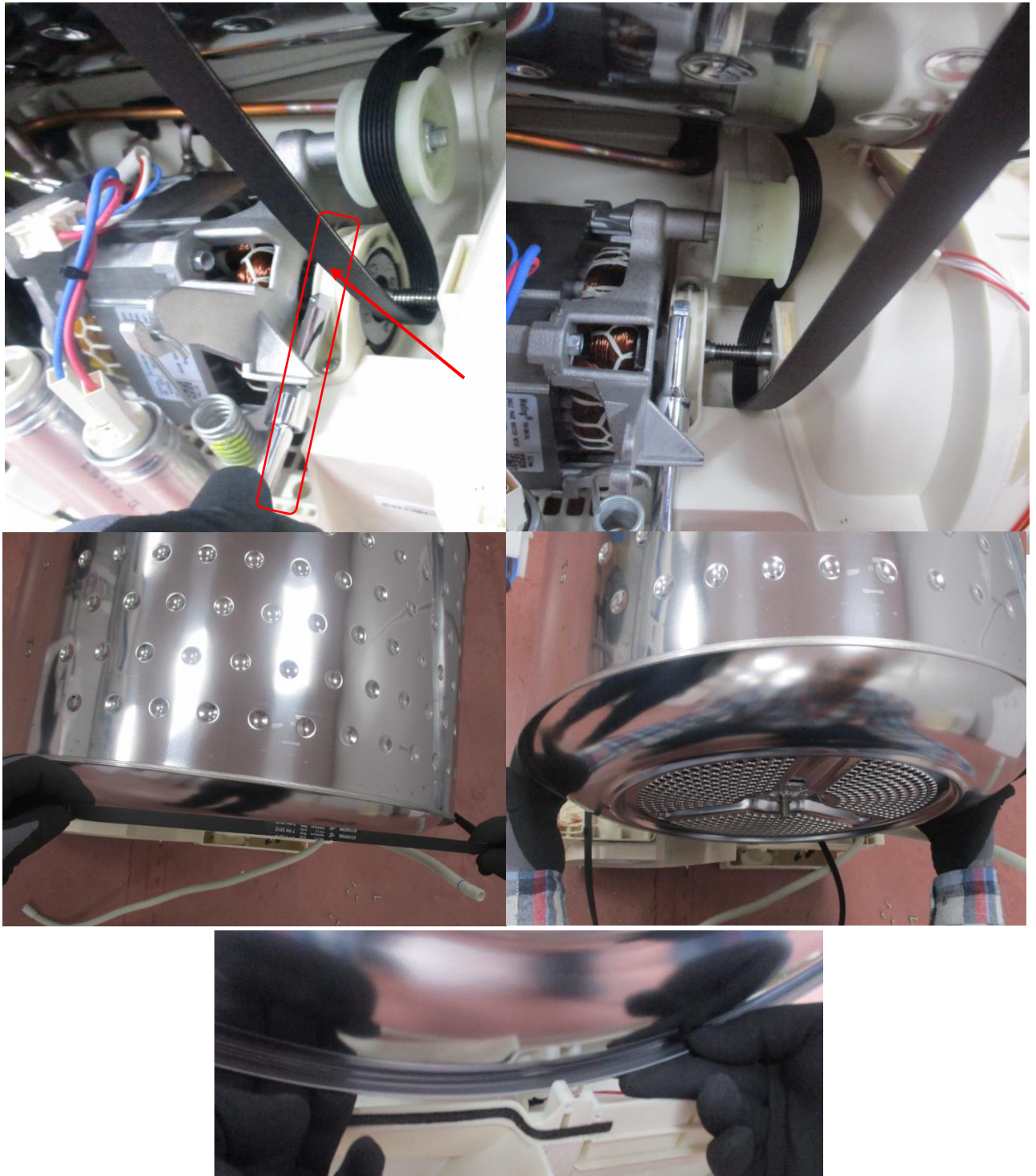

1. Motor should be moved up to prevent to press spring. **Spring must not be stretched more than 40 mm. End and beginning of the spring must not be deformed.** So, belt will be released as shown in the photo.
2. Remove the belt on the drum
3. Pull up the drum to separate with basement plastic. Then, pull back to remove.

6.15. Motor

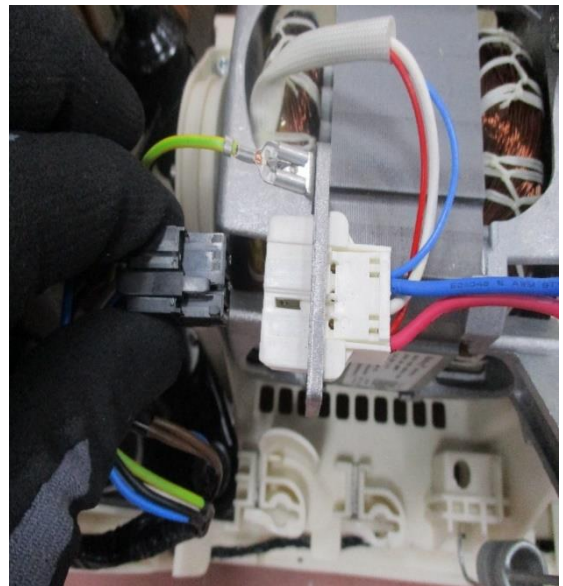
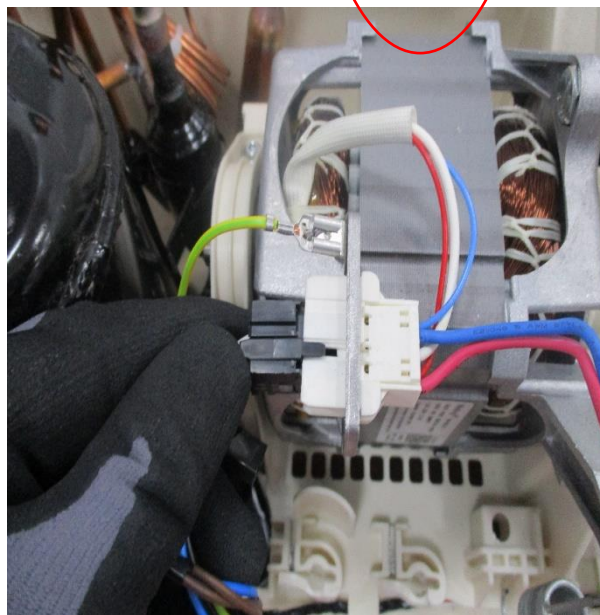
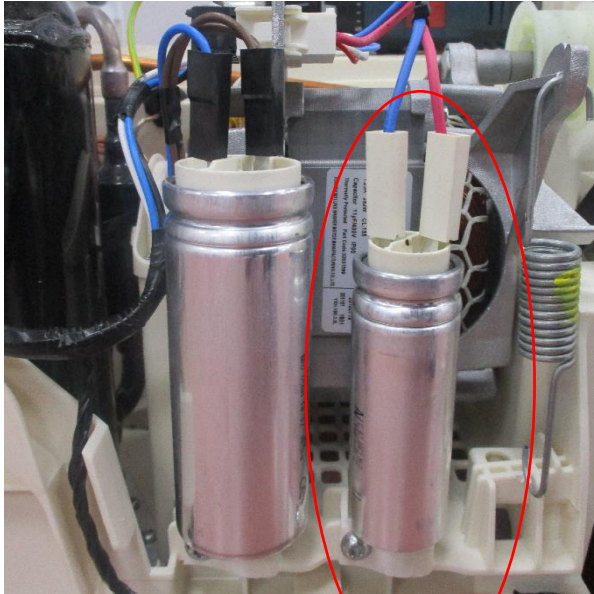

1. Remove capacitor sockets and other sockets from motor.
- PS: before removing the motor, process fan should be removed.
- You can apply the same instruction to change the belt

6.15.Motor

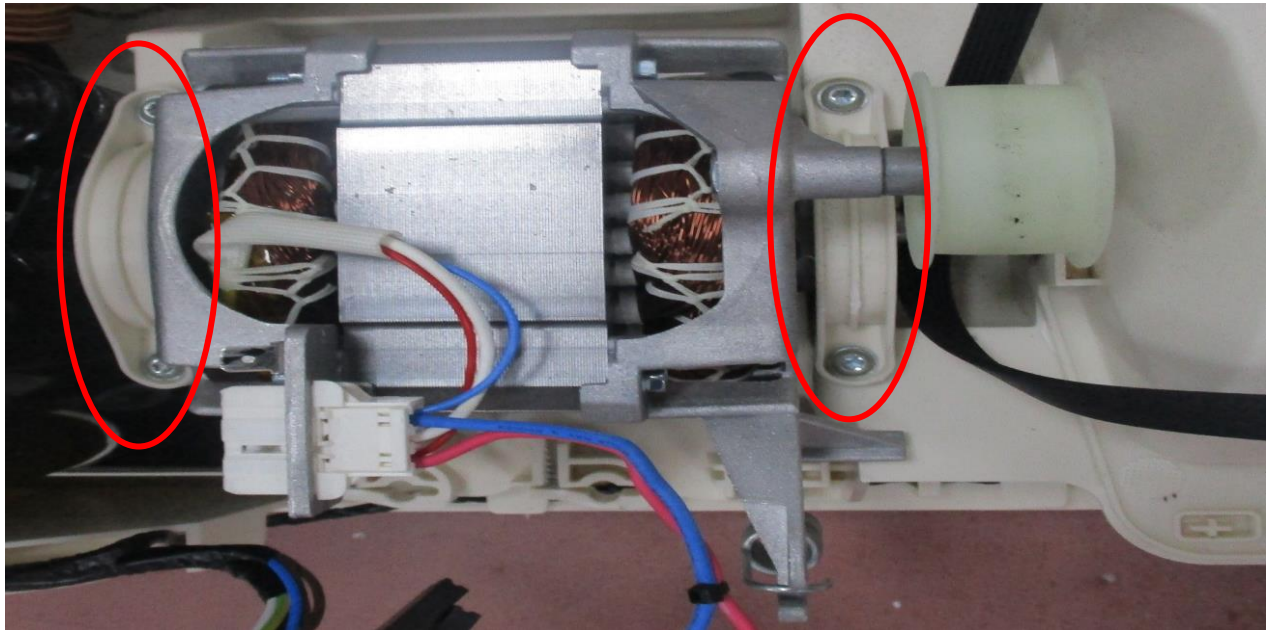

2. Remove 4 screws from motor fixing plastic
3. Take the motor from basement plastic as shown in the photo.

6.16.Capacitors



1. Remove all sockets from motor.
2. Remove the screw on bottom of capacitor then disassemble the capacitor
3. The capacitor is removed by turning.

6.16.Belt

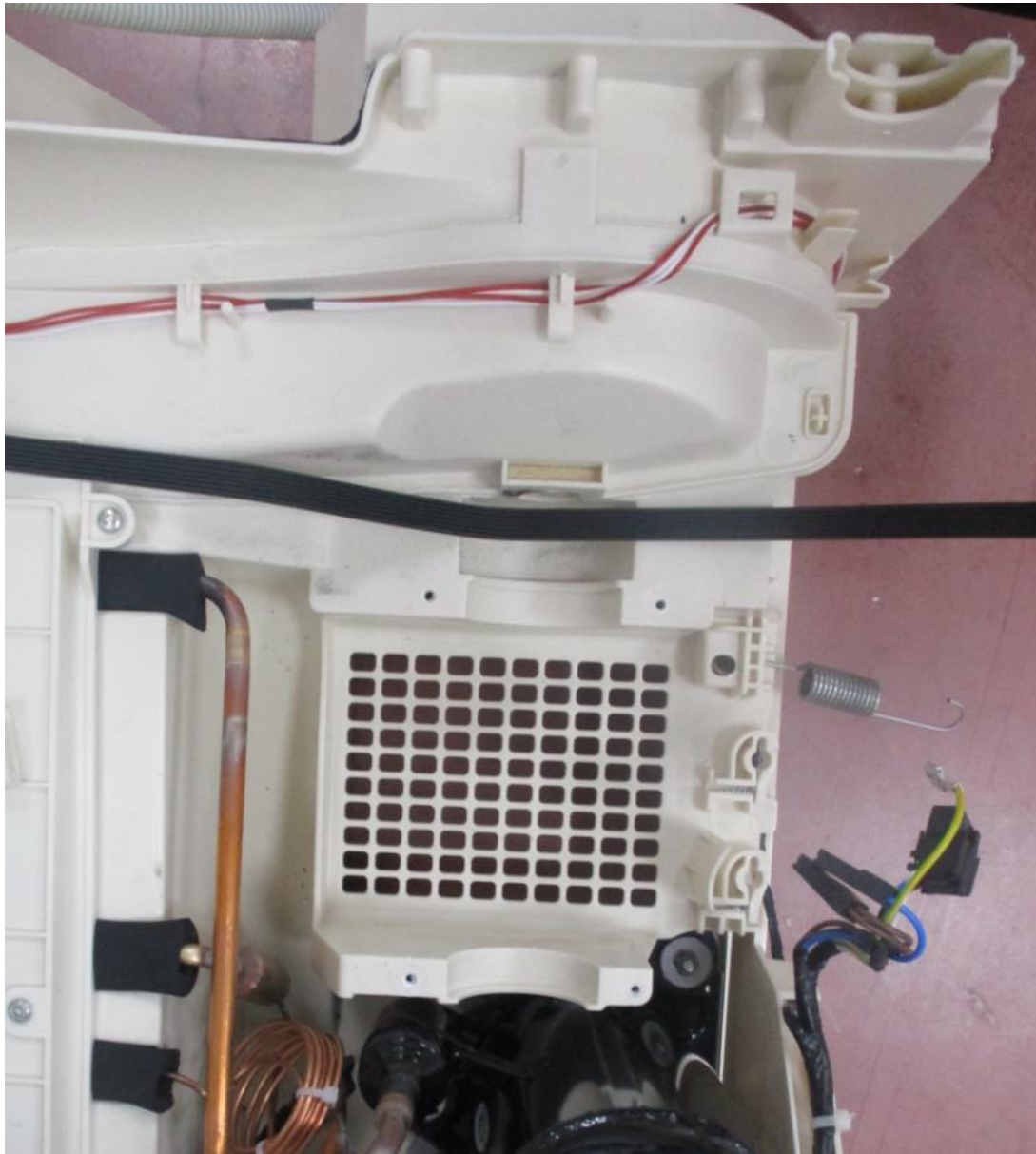

1. After you should remove drum and motor than change the belt. As informed on drum disassembling section; **Spring must not be stretched more than 40 mm. End and beginning of the spring must not be deformed.**

6.18. Humidity Sensor



1. Remove 5 screws from humidity sensor plastic.
2. Remove the humidity sensor cable as shown in photo.

6.19. Door latch

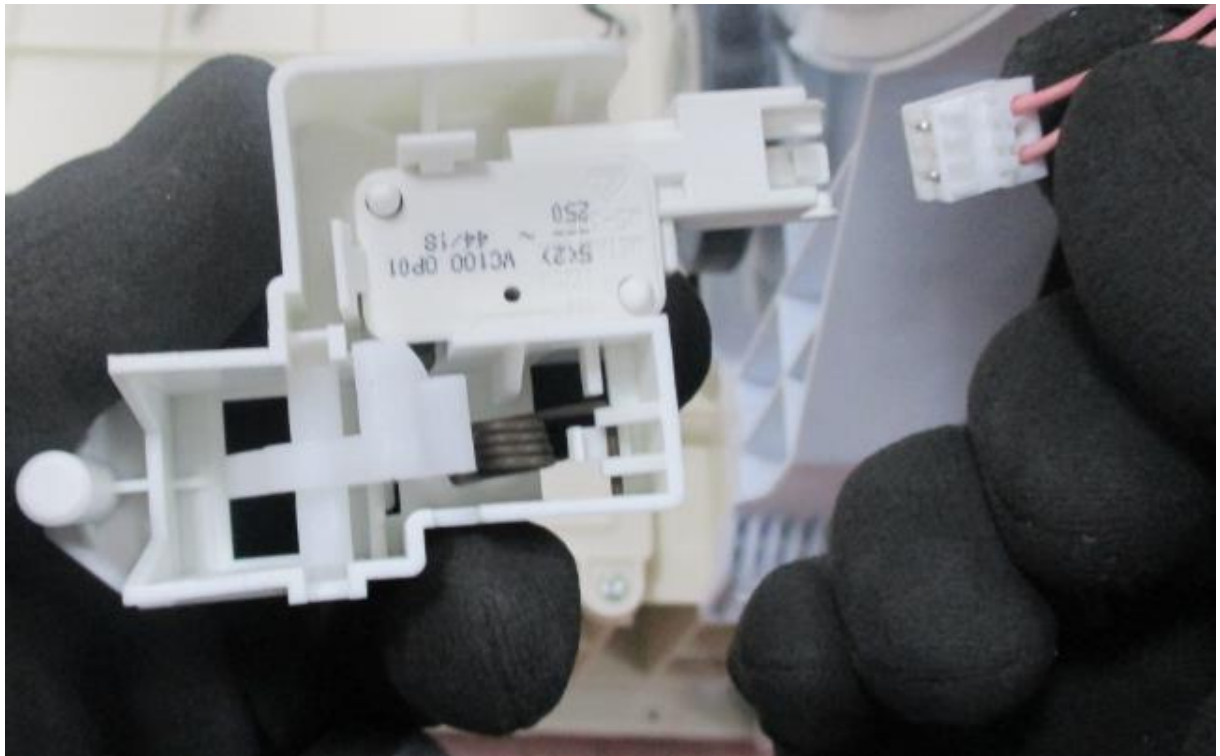
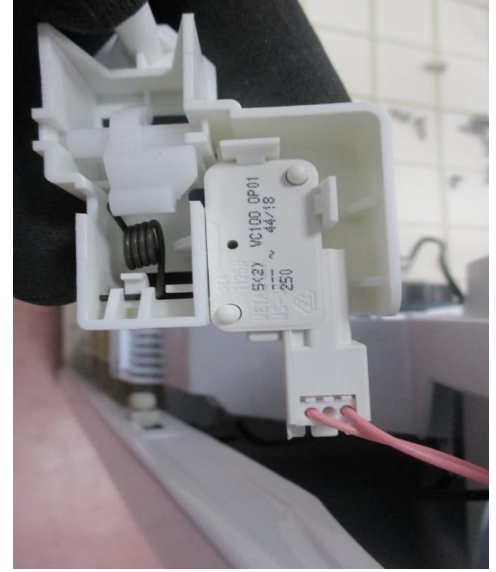

1. Remove door latch screw from front panel.
2. Separate the door latch socket from door latch as shown in the photo.

6.20. Plinth



1. Remove the plinth screw
2. Remove the plinth as shown in the photo

6.21. Cooling Fan

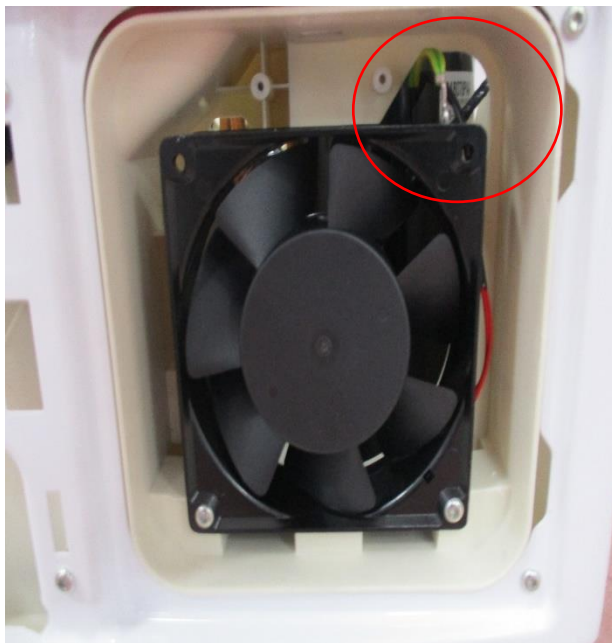
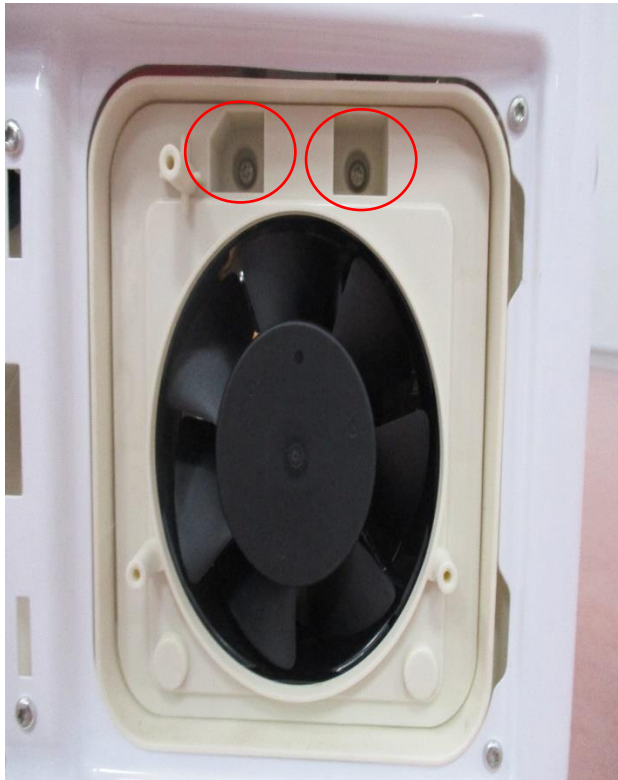

1. Remove screws on cooling fan fixing plastic
2. Remove the cooling fan fixing plastic as shown in the photo.
3. Disassemble the cooling fan by removing the fan screws and fan ground wire.

6.22. Plinth Cover

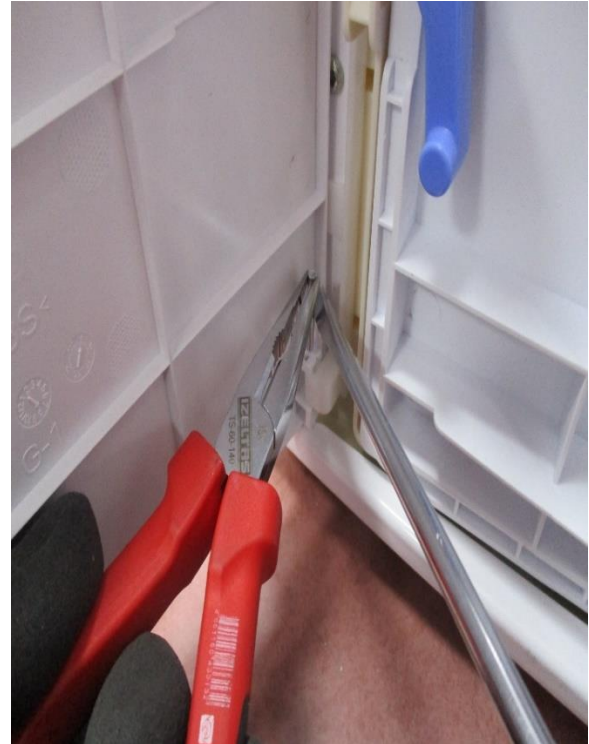

1. Remove 2 plinth pin on Plinth cover.

6.23. Door

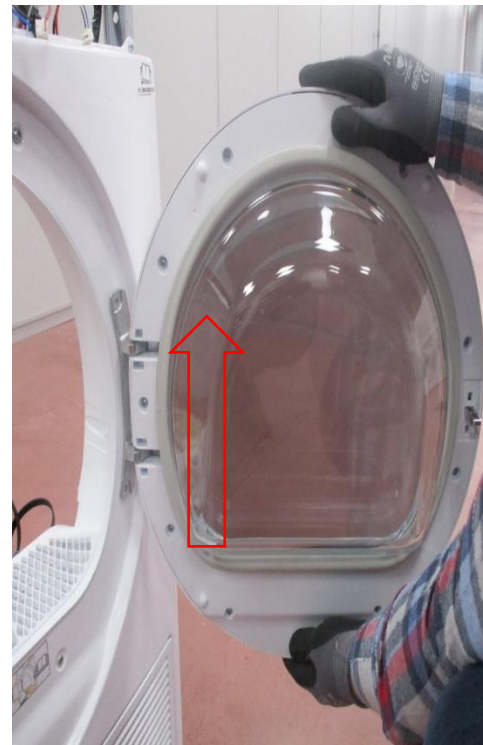

1. Remove 2 screws that fix the door.
2. Pull the door by lifting up.

6.24. Drum Bearing Wheel



1. Remove wheels as shown in the photo

6.25. Drumlight

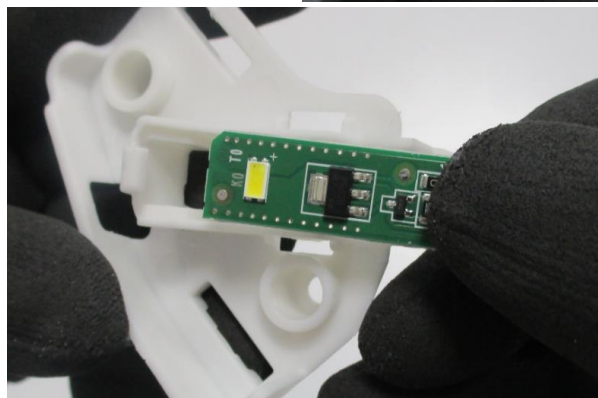
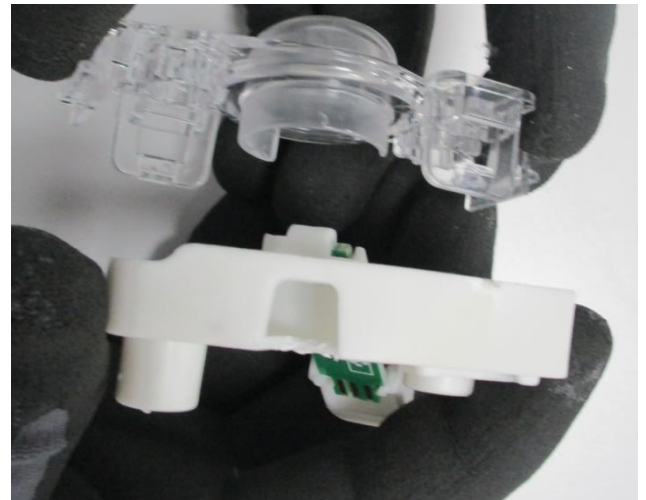
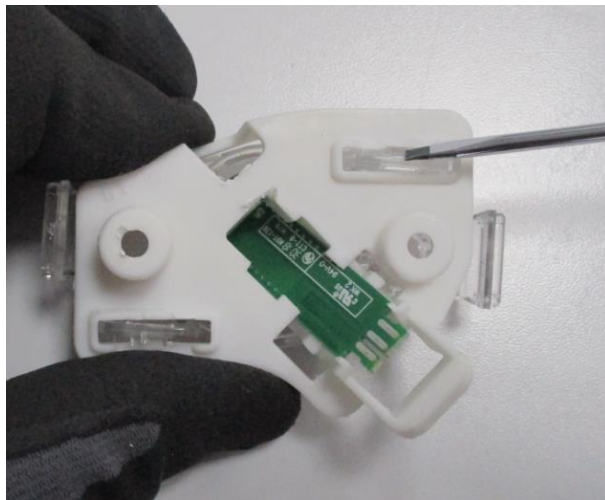

1. Remove Drumlight group from Front Shield
2. Remove the drum light socket.
3. Remove the drum light card.

6.26. Front Panel



1. Remove 16 screws on the front panel
2. While removing the front panel, the cable of the door latch must also be removed.

6.27. Door NTC



1. Remove the socket from NTC sensor on the basement plastic.
2. Remove the NTC from basement plastic by hand or tool.

6.28. Side Bracket

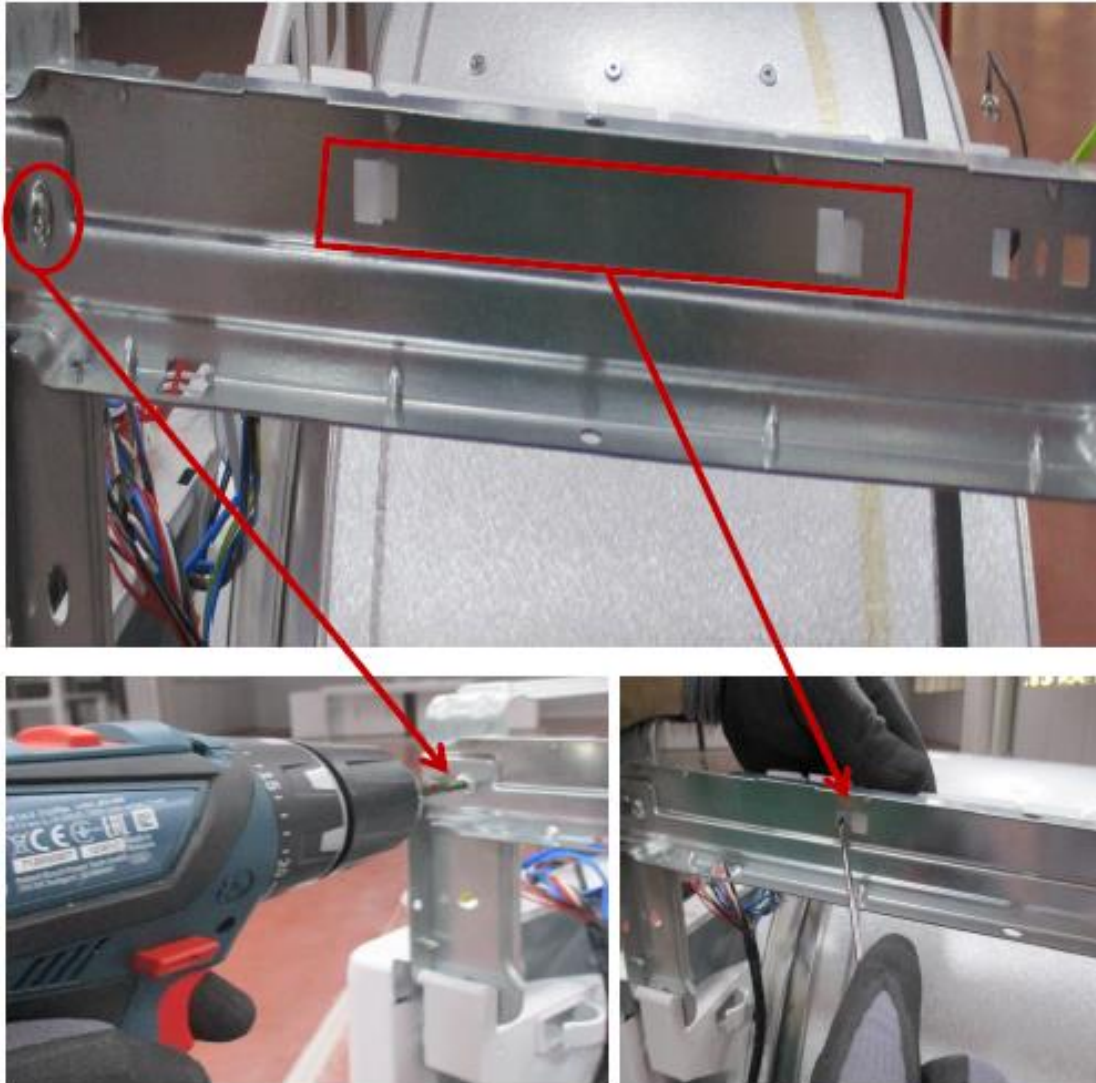

1. Remove cable holder plastic clips shown in the photo. (For right side bracket)
2. Remove screw from bracket which is fixing side bracket and top bracket. (Rear panel was removed before.)

6.29. Front Shield

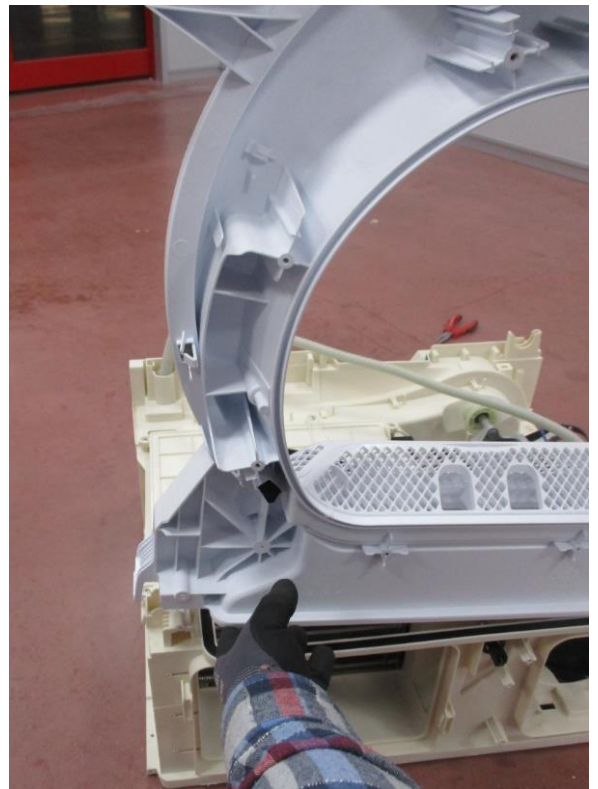

1. Remove 2 screws in the bottom.
2. Open clips on the left side.
3. The front shield should be lifted as shown in the photo.

6.30.Front Isolation Foam

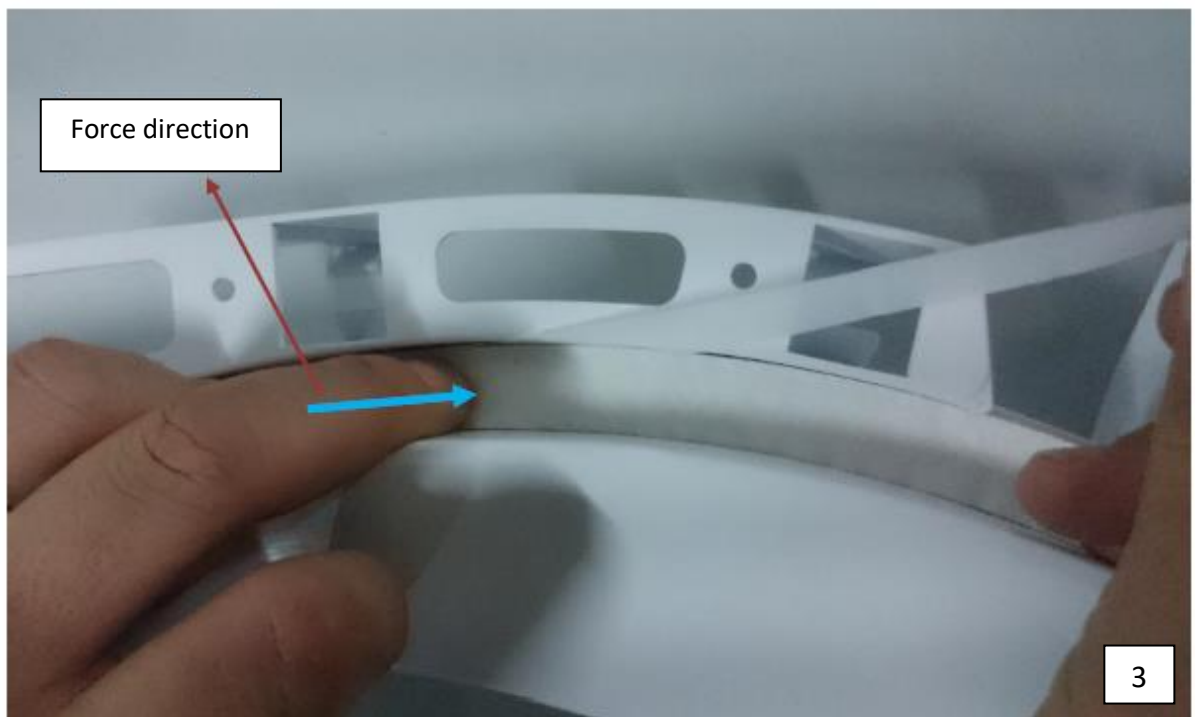
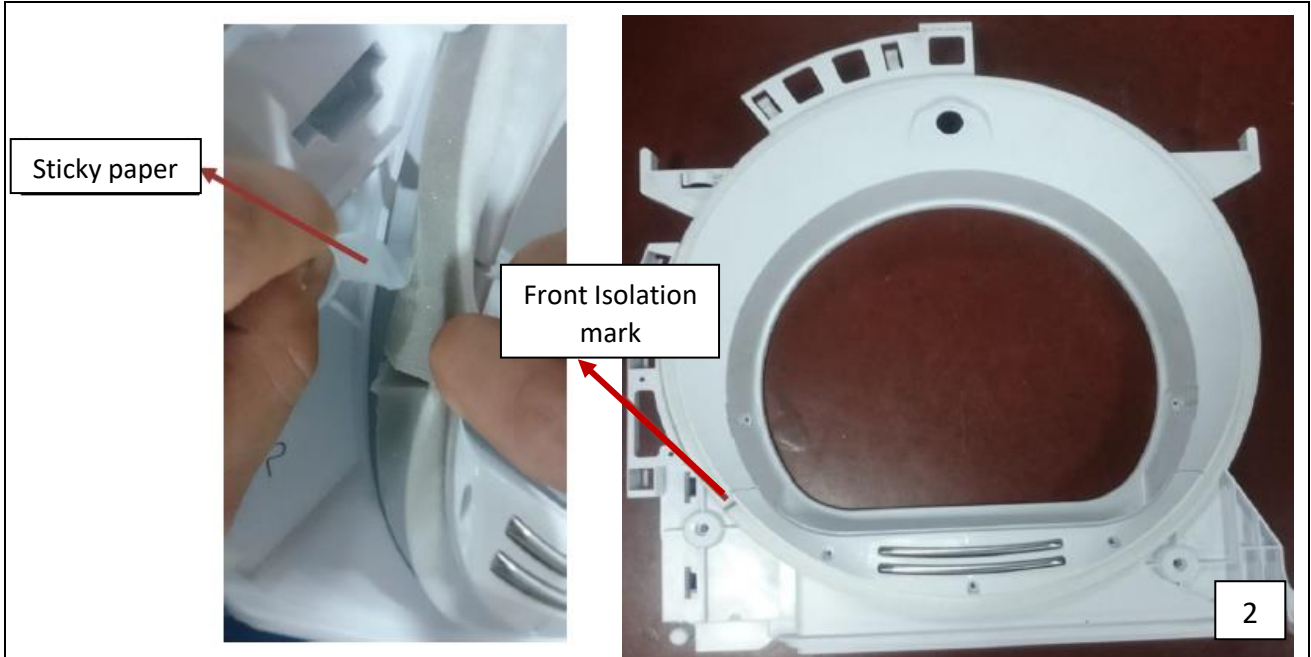

1. It is important to install the new felt correctly after it has been removed from the slot at the front shield.
2. Before Sticky paper is opened, front isolation foam should be placed to slot on front shield. Front isolation foam mark should be on left bottom of front shield.
3. Stick the foam on front shield as shown in the photo.
4. Isolation should be centered on slot

6.31. Cable Group

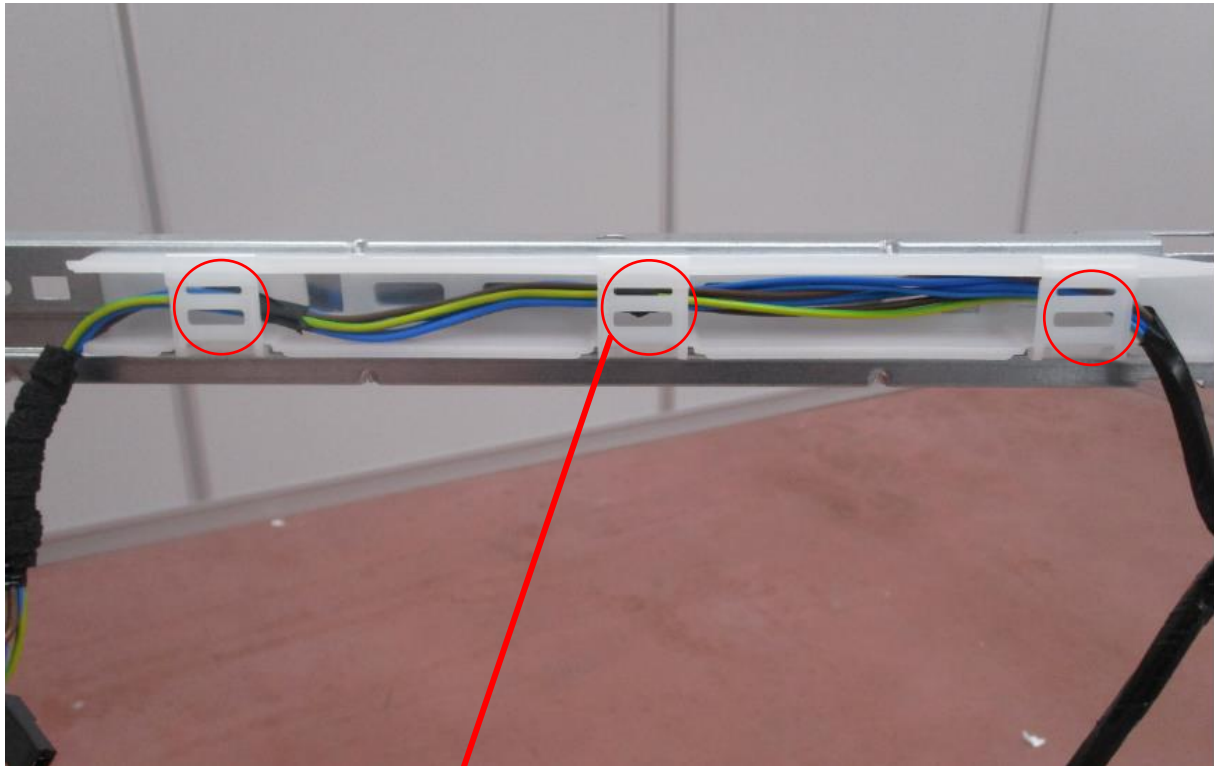

1. Open the cable holder plastic clips on side bracket.
2. Remove cable holder plastic fixing clips as shown in the photo.

6.31. Cable Group

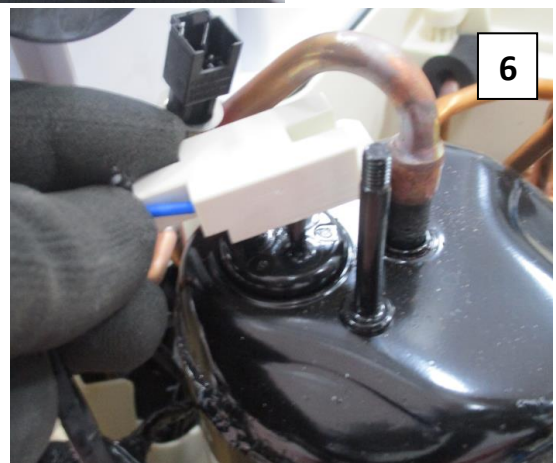
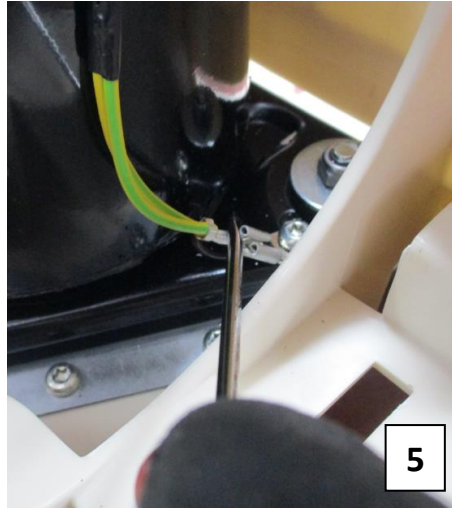
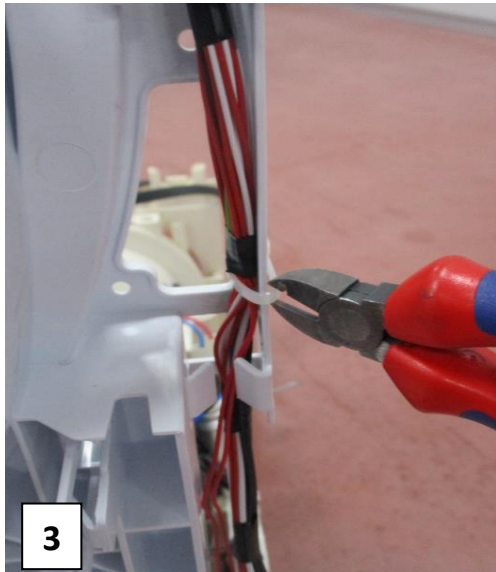
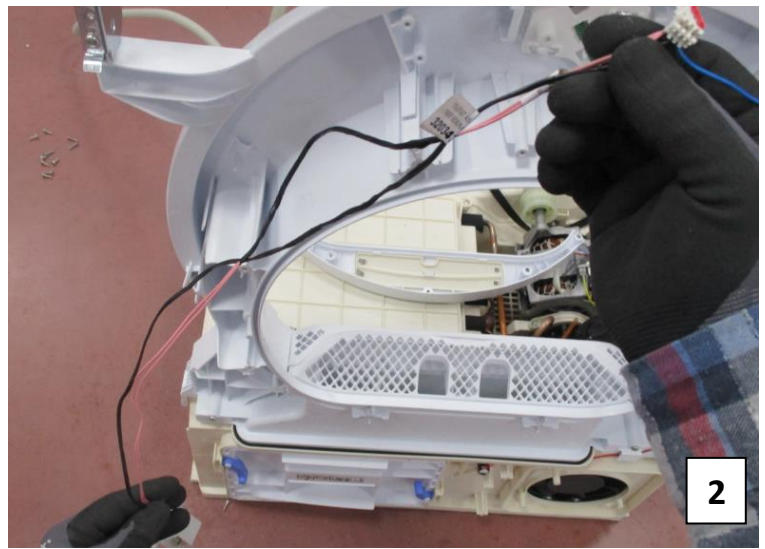
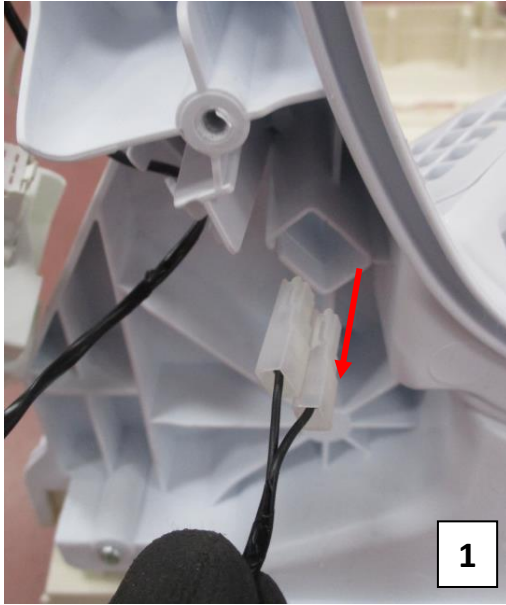

1. Humidity Sensor Cable
2. Door Latch Socket Cable
3. Cable Group of Front Shield

4. Compressor NTS Socket
5. Compressor Ground Cable
6. Compressor Socket

7. 7. COMPONENT SPECIFICATIONS AND MEASUREMENTS

7.1. Motor

The dryer has an asynchronous motor. In the photo on the right, the socket on the motor are shown to be measured by multiple counters. It is driven with triac via the electronic card (to give energy) and relay (for direction control).

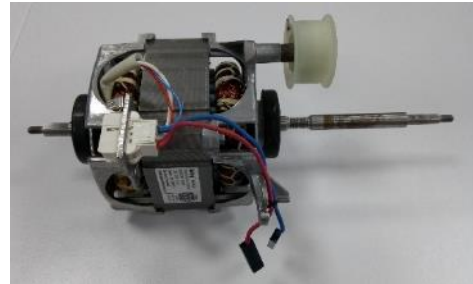

Technical Features

Type: single-phase asynchronous motor
 Power: 200 W (Unloaded drum)
 Main windings: 21.5±7% (20 °C temp.)
 Aux windings: 19.5±7% (20 °C temp.)

Motor speed : 2750 rpm (Unloaded drum)
 Drum speed : 52 ± 2
 Capacitor value : 11 µF ± %5

Component Test

- Check whether the motor cable is connected to the motor connector.
- Check the connection of the capacitor cables
- Measure the resistance values and check the capacitor values
- Check whether it is working by connecting via the terminals 1 and 2 (Blue-White) connection
- If it is working, revolution of the drum is measured in unloaded state.

The terminals 1-3 of the motor should be connected with capacitor

Resistance measurement of main winding: Terminal 1 -2 (Blue-White) is measured.

Resistance measurement of aux winding: Terminal 3 -2 (Red-White) is measured.

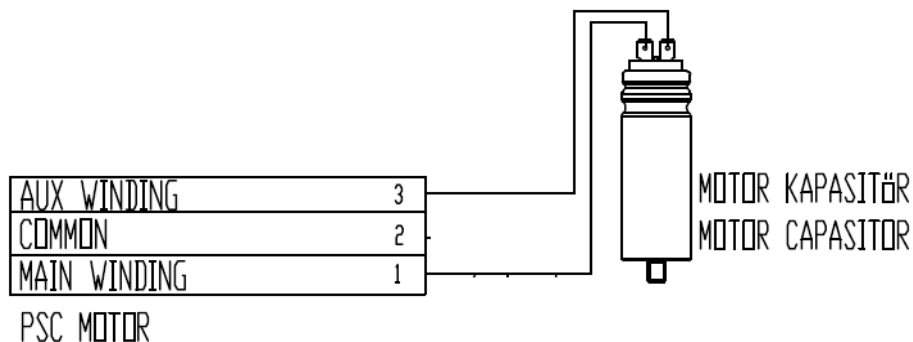

7.1.1. Motor Measurements



7.2. Pump

In Tumble Dryer models, the pump is used to transport the water that accumulates in the condensation chamber to tank in the drawer area. One triac is measured on the electronic card.



Technical Features

Resistance : $764 \pm 10\%$ ohm
Voltage: 220-240 Volt
Frequency: 50 Hz

Input Power : 13W max

Component Test

- Check the connection of the pump connector
- Check the pump resistances
- Check whether pump is working, by feeding externally
- If the pump is working, the water in the tank is unloaded by running the pump Then, Unload 500 ml of water from water tank to pump reservoir and check whether water is pumping.
- While pump is working, if water is not reached into water tank, hoses should be checked.

7.2.1 Pump Measurements



7.3. Electronic Card

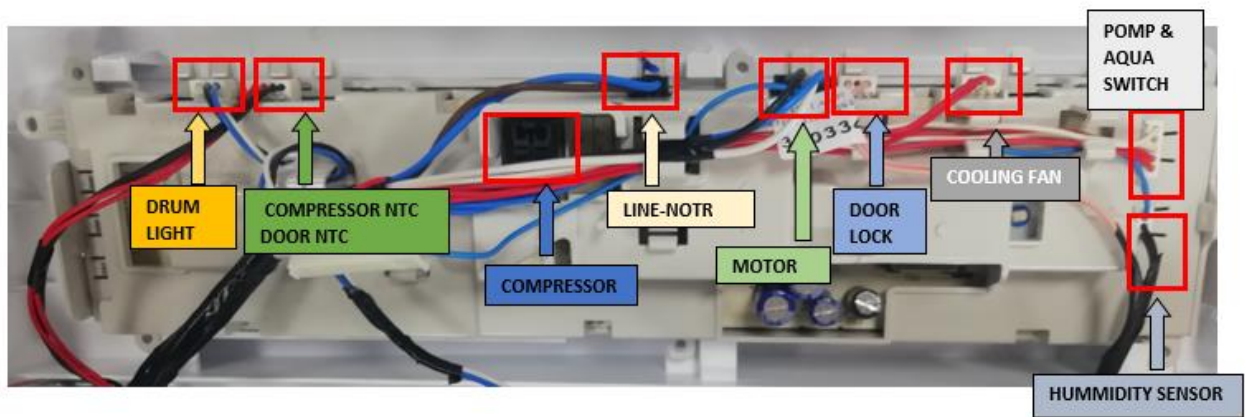
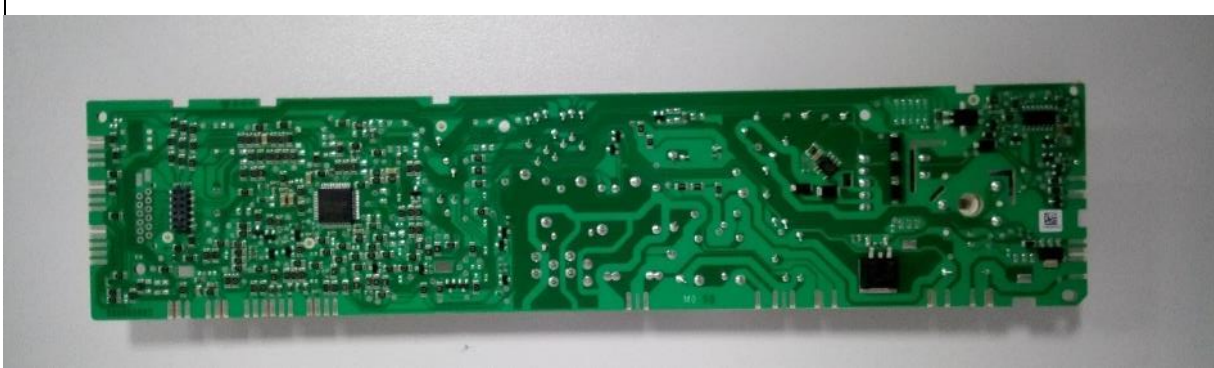

Technical Features

Electronic card is single sided printed circuit board and CEM-1 material

The upper picture shows where the components sockets are inserted.

7.4. Door/Compressor NTC Sensor

Two NTC sensors are used. The NTC resistance decreases when the temperature rises.



Technical Features

Door NTC Resistance : 12 kΩ (Measured from IDC connected to electronic card)

Compressor NTC Resistance : 12 kΩ (Measured from IDC connected to electronic card)

Component Test

- Resistance is measured from IDC connected to electronic card

7.4.1. Door NTC Sensor Measurements



7.5. Compressor

The dryer has an compressor with an asynchronous motor. In the photo on the right, the terminal on the compressor are shown to be measured by multiple counters. It is driven with relay via the electronic card (to give energy) and relay drive the compressor only one direction.



Technical Features

Type: single-phase asynchronous motor
 Power: 350 W (Unloaded drum)
 Main windings: $9.3 \pm 7\%$ (25 °C temp.)

Aux windings: $8.75 \pm 7\%$ (25 °C temp.)
Motor speed : 2928 rpm (Unloaded)
Gas Type: R290
Capacitor value : $20 \mu\text{F} \pm 5\%$
Compressor Capacity: $7.8 \text{ cm}^3/\text{rev}$

Component Test

- Check whether the compressor cable is connected to the compressor terminal.
- Check the connection of the capacitor cables
- Measure the resistance values and check the capacitor values
- Check whether it is working by connecting via the terminals S,R and C connection
- If it is working, start the machine and check the drum temperature.

The terminals S and R of the motor should be connected with capacitor.

Resistance measurement of main winding: Terminal C-R is measured.

Resistance measurement of aux winding: Terminal C-S is measured.

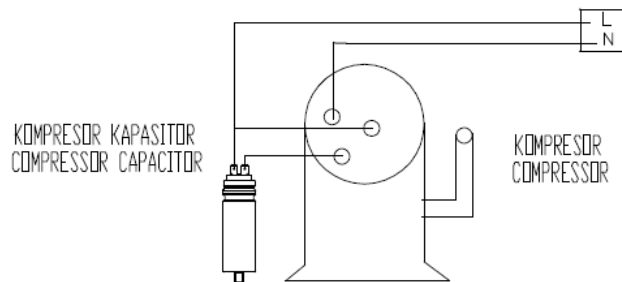

7.5.1. Compressor Measurements



7.6. Door Latch

Door latch locks when the door is closed. It's designed to be opened from inside, in case of children are in the drum



Component Test

- When the door is closed, check whether there is electrical transmission from IDC connected to electronic card
- Check the connection of the component connector

7.6.1 Door Latch Measurements



7.7. Humidity Sensor

The Humidity Sensor measures the amount of dryness of the laundry in the drum.



Component Test

- Each humidity sensor plate is checked whether there is electrical transmission from IDC connected to electronic card.
- Check the connection of the component connector

7.7.1 Humidity Sensor Measurements



7.8. Cooling Fan

The dryer has an cooling fan with an asynchronous motor. In the photo on the right, the terminal on the compressor are shown to be measured by multiple counters. It is driven with triac via the electronic card (to give energy)



Technical Features

Type: single-phase AC fan

Power: 28 W

Main windings: 600±7%

Motor speed : 2600/3000 ±10%

Component Test

- Check whether the cooling fan cable is connected to the fan terminal.
- Measure the resistance values

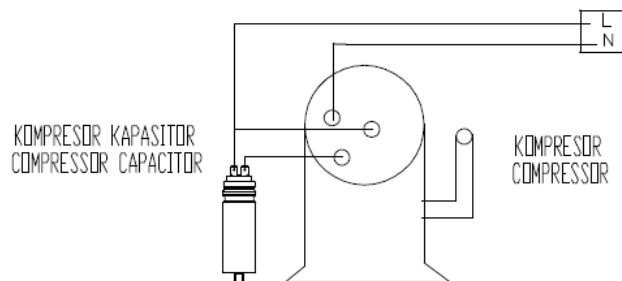

7.8.1. Cooling Fan Measurements

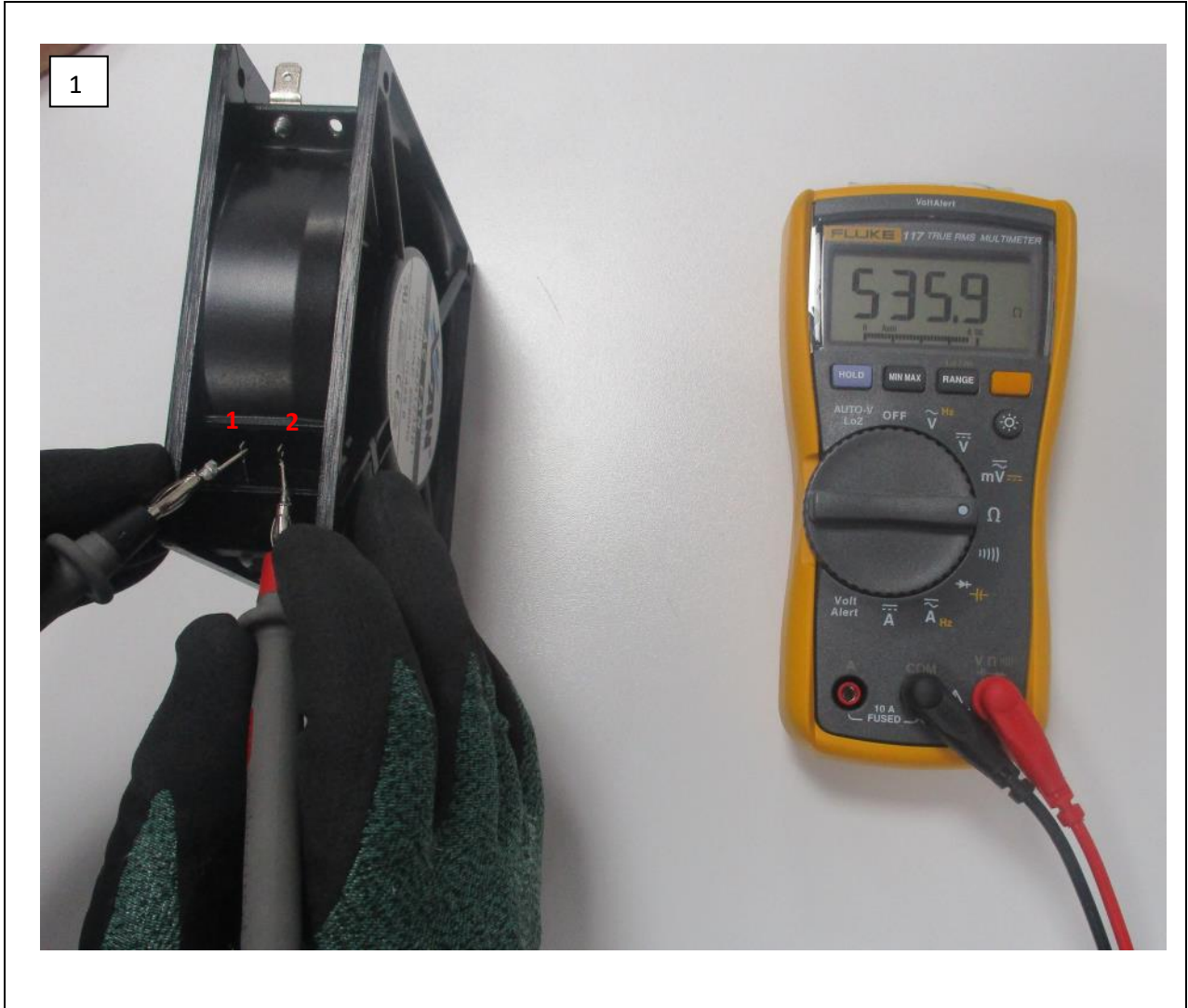

7.9. Drumlight

Drumlight lights inside of the drum



Component Test

Check whether there is electrical transmission from IDC connected to electronic card.

8. TROUBLESHOOTING

