SECHE-LINGE MANUEL DE SERVICE

Bandeau HP T2 Touch

CONTENTS

1. OVERVIEW AND WORKING PRINCIPLE.....	4
1.2. Working Principle:.....	4
2. TECHNICAL SPECIFICATIONS.....	5
3. INSTALLATION.....	5
3.1. Issues that should be informed to customer.....	5
4. CONTROL PANEL AND PROGRAM SELECTION TABLE.....	6
4.1. Control Panel.....	6
4.2. Program List.....	6
4.3. Children’s Safety.....	7
5. FAILURE MODES AND SERVICE AUTOTEST.....	7
5.1. Failure Modes and Warning Leds.....	8
5.2. Service Autotest Steps.....	9
6. DISASSEMBLY.....	11
6.1. Top Plate.....	11
6.2. Control Panel.....	12
6.3. Control Panel.....	13
6.4. Electronic Card.....	14
6.5. UI Card.....	15
6.6. Side Panel.....	16
6.7. Supply Cable.....	18
6.8. Emi Filter.....	19
6.9. Rear Cover.....	20
6.10. Pump.....	21
6.11. Process Fan.....	23
6.12. Rear Panel.....	24
6.13. Rear Isolation Group.....	26
6.14. Rear Bearing Group.....	27
6.15. Water Tank Housing.....	28
6.16. Drum.....	29
6.17. Motor.....	30
6.18. Capacitors.....	32
6.19. Belt.....	33

6.20. Humidity Sensor	34
6.21. Door latch	35
6.22. Plinth	36
6.23. Cooling Fan	37
6.24. Plinth Cover.....	38
6.25. Door.....	39
6.26. Drum Bearing Wheel	40
6.27. Drumlight.....	41
6.28. Front Panel.....	42
6.29. Door NTC.....	43
6.30. Side Bracket	44
6.31. Front Shield.....	45
6.32. Front Isolation Foam	46
6.33. Cable Group	47
7. 7. COMPONENT SPECIFICATIONS AND MEASUREMENTS	49
7.1. Motor	49
7.1.1. Motor Measurements	50
7.2. Pump	51
7.2.1 Pump Measurements	52
7.3. Electronic Card	53
7.4. Door/Compressor NTC Sensor	53
7.4.1. Door NTC Sensor Measurements	54
7.5. Compressor.....	54
7.5.1. Compressor Measurements	56
7.6. Door Latch	57
7.6.1 Door Latch Measurements	57
7.7. Humidity Sensor	58
7.7.1 Humidity Sensor Measurements.....	58
7.8. Cooling Fan	59
7.8.1. Cooling Fan Measurements	60
7.9. Drumlight.....	60
8. TROUBLESHOOTING	61
.....	66

1. OVERVIEW AND WORKING PRINCIPLE

1. Top Plate
2. Control Panel
3. Loading Door
4. Plinth
5. Plinth opening slot
6. Ventilation grills
7. Adjustable feet
8. Plinth cover
9. Type plate
10. Lint filter
11. Drawer Cover

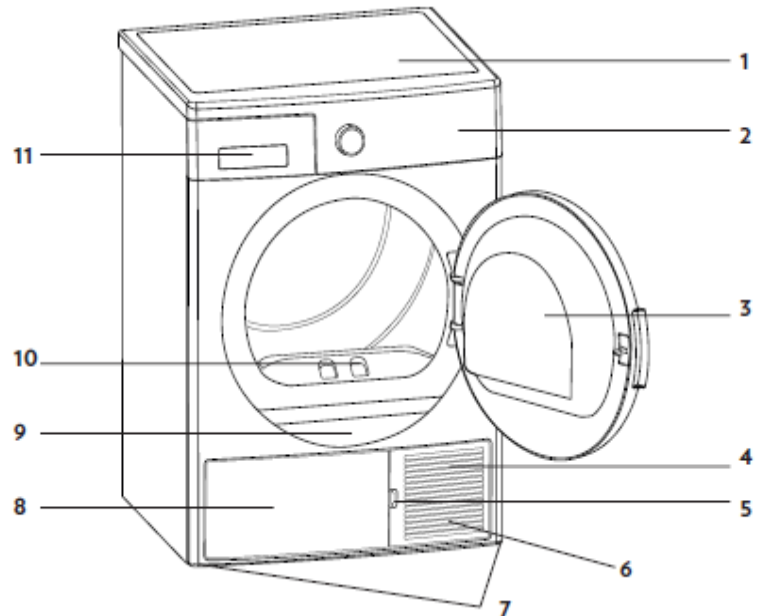

1.2. Working Principle:

In the heat pump dryer machine, heated air is sent to the wet laundry in the drum from the heater side of the coil which called by condenser. The humidity of the laundry is taken and reaches the cold side of the coil which called by evaporator via filter. With a compressor, refrigerant is passed through inside of the tubes of coils both condenser and evaporator. A capillary causes resistance against to refrigerant flow. By this way, the evaporator surface is cooled and condenser surface is heated. The hot and humid air from the drum is reached cold evaporator surface and the humidity on it is left as water. The condensing water in the evaporator is pumped to the water tank by the pump.

	HP T2touch PANEL	CUSTOMER SUPPORT
	SERVICE MANUAL	

2. TECHNICAL SPECIFICATIONS

Manufacturer	Vestel White Goods	
Capacity (max)	7 kg	8 kg / 9kg
Height	Min: 845mm Max: 855 mm	Min: 845mm Max: 855 mm
Depth	563 mm	609 mm
Width	596 mm	596 mm
Net weight (with plastic door)	44,8 kg	46,8 kg
Net weight (with glass door)	46,8 kg	48,8 kg
Voltage	220-240 V	
Working Temp.	+5°C - +35°C	
Power	1000 W	

3. INSTALLATION

3.1. Issues that should be informed to customer

1. Drying machine must be grounded.
2. Lint filter must be cleaned after each use
3. Water tank must be unloaded after each use
4. Even if the heat exchanger cleaning warning les is not on : clean the heat exchanger after every 30 drying processes or once a month
5. The amount of laundry should be appropriate to program.
6. Use this product only for laundry with a label that indicates it is suitable for drying.
7. Children should not play with appliance.
8. This product contains environmental friendly but flammable **R290** gas. Keep open flame and fire sources away from the product.
9. Ventilation grills should not be closed.
10. The service life time of tumble dryer is 10 years.
11. Adjustable feet should not be removed.
12. There should not be lockable or sliding door in the installation area
13. Never spray or pour water onto the dryer to wash it. There is a risk of electric shock.

Please ensure that customer reads the user manual



1. Check the environmental conditions. (Voltage, current etc.)
2. Ensure that product is used correctly
3. Check the machine with **Service Auto Test**. If the system displays failure code, find the corresponding code in the failure code list then act according to this.
4. Check the electronic connections

4. CONTROL PANEL AND PROGRAM SELECTION TABLE

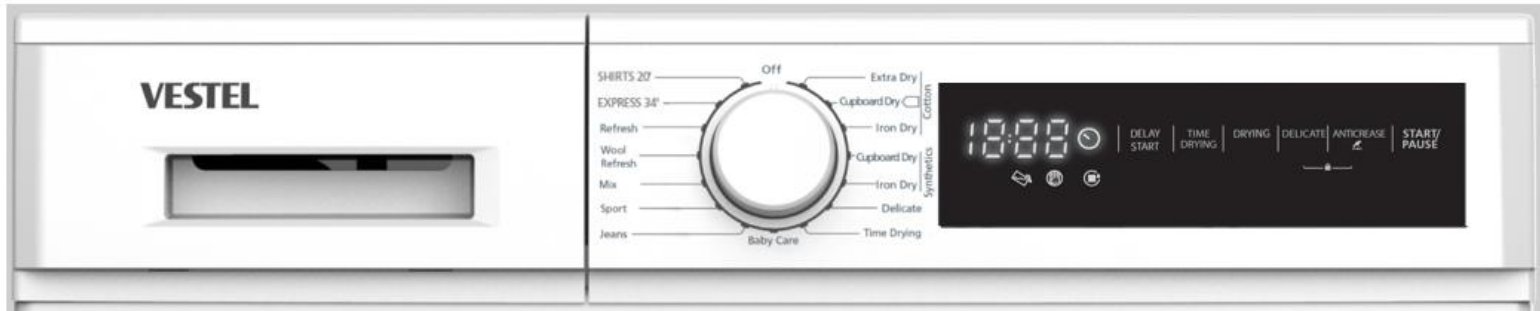
4.1. Control Panel



Display Symbols

Water tank warning indicator	
Lint filter cleaning warning indicator	
Heat exchanger cleaning warning indicator	

4.2. Program List

KNOB POSITION	PROGRAM
1	Cotton Extra Dry
2	Cotton Cupboard Dry
3	Cotton Iron Dry
4	Synthetics Cupboard Dry
5	Synthetics Iron Dry
6	Delicate
7	Time Drying*
8	Baby Care
9	Duvet
10	Sport
11	Mix
12	Wool Refresh
13	Refresh
14	Express 34 '
15	Shirts 20 '
16	OFF

***The machine has humidity sensor that detects whether the laundry dry or not. At the programs that work with humidity sensor laundry does not dry in fixed time. Duration is constantly updates according to humidity data taking from laundry.

*****Time Drying Program:** Humidity sensor is deactivated. The program ends when the time is up, without checking the humidity of the laundry.

*****Express 34' / Shirts 20 ':** Humidity sensor is activated. The program time may extend, if the customer use different laundry according to the load in the program description.

Express 34' : 2 kg of cotton shirts spun at a high speed in the washing machine are dried in 45 minutes.

Shirts 20' : 2 to 3 shirts are ready for to be ironed in 30 minutes.

*****Delicate:** Delicate fabrics are dried for a longer time at a low temperature.

*****Wool Refresh / Refresh:** Compressor is deactivated. The air is not heated.

4.3. Children's Safety

There is a child lock option to avoid changes in the programme flow when keys are pressed during the programme. To activate the child lock, press and hold the "Delicate" and "Anti-Crease" keys simultaneously for 3 seconds.

When the child lock is active, all keys will be deactivated. Child lock will be deactivated automatically at the end of the programme. When activating/deactivating the child lock, "CL" will visualize on display for 2 sec and then becomes off; and an audible warning will be heard.

Warning; when the product is running or the child lock is active, if you turn the programme selection knob, you will hear an audible warning and "CL" will visualize on display for 2 sec and then becomes off. Even if you set the programme knob to another programme, the previous programme will continue running. To select a new programme, you need to deactivate the child lock and then set the programme selection knob to "Off" position.

Then, you can select and start the desired programme.

5. FAILURE MODES AND SERVICE AUTOTEST

*****Service auto test must be run for every service call.**

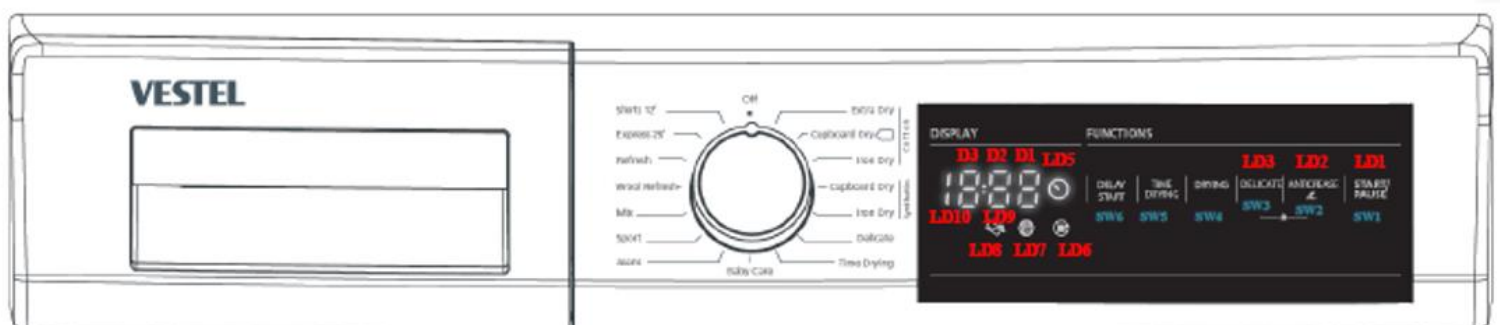

5.1. Failure Modes and Warning Leds

T3 HEAT PUMP MODEL ERROR CODES	
ERROR CODE	REASON
E00	T3 UI board doesn't receive communication from mainboard
E03 / 	Aquaswitch connector is disconnected
E04	Compressor connector is disconnected
E05	Compressor NTC connector is disconnected
E06	Door NTC connector is disconnected
E07	Motor connector is disconnected, motor is locked
E08	Voltage fluctuation

Notes For Service autotest:

*Service can not pass the current step before completing the minimum duration

*When minimum duration for each step (5 sec) is completed, filter led makes slow blink to indicate that service can pass the next step

*For error codes, leds must make fast blink

5.2. Service Autotest Steps

STEPS	Control	Mini Step Dura tion*	Error code	Led Indication	Possible Errors
The Routine to Enter Servis Autotest	<p>Set program knob at position 3. Push SW5 button. Keeping SW5 button pushed, turn program knob to position 1. After 3 sec, SAU is shown in display. Then press Start/Pause button. Machine enters to service autotest.</p> <p>When knob positioned to program 2, control steps starts.</p>	5 sec	-		
Step 2 (Knob Position 2)	Dryer check Aquaswitch, if aquaswitch ON go to next step (pump activation), if aquaswitch OFF give water tank full error	10sec	E03	-	<p>*Aquaswitch connector is taken out *Aquaswitch connector is short circuit *Styrofoam is borken or not</p>
Step 3 (Knob Position 3)	Pump is on	5 sec	-	-	<p>Service must pour water to pump reservoir and check whether water is pumped to tank. If water is not pumped to water tank; *Pump connector is taken out</p>
Step 4 (Knob Position 4)	Motor CCW (Tumble CW)-Motor stops	10 sec	-	-	<p>Service must check whether tumble is moving to CW. If not; *Motor connector is taken out *Motor might be locked *Motor belt might be dislocated</p>

Step 5 (Knob Position 5)	Motor CW (Tumble CCW) -Motor stops	10 sec	-	-	Service must check whether tumble is moving to CCW *If tumble is moving to CW again, then motor relay short circuit CCW
Step 6 (Knob Position 6)	Check Heater NTC if heater NTC T=255	5 sec	E05	-	*Heater NTC connector is taken out or short circuit
Step 7 (Knob Position 7)	Check Door NTC if heater NTC T=255	5 sec	E06	-	*Door NTC connector is taken out or short circuit
Step 8 (Knob Position 8)	Compressor OFF- Motor CCW (Tumble CW) OFF- Cooling fan ON	10 sec	-	-	Service must check power of at the home voltage and fan will be controlled manually by technical service.
Step 9 (Knob Position 9)	Compressor ON- Motor CCW (Tumble CW) -motor off	10 sec	-	-	Service must check power of at the home voltage.
Step 9 (Knob Position 9)	Check conductivity sensor when door is opened and motor is off	5 sec	E01	-	Service puts his hand on the humidity sensor plates and software checks sensor data *If sensor data=0, humidity sensor connector is taken out
Remove the last error (Knob Position 1)		5 sec	DEL	DL is visualized on display and make fast blink for 2 sec for T0.DEL is visualized on display and make fast blink for 2 sec	When the knob positioned to program 1, service will push the both SW4 and SW5 for T0/T1 (child lock mode). When the knob positioned to program 1, service will push the both SW2 and SW3 for T2 (child lock mode).

6. DISASSEMBLY

6.1. Top Plate

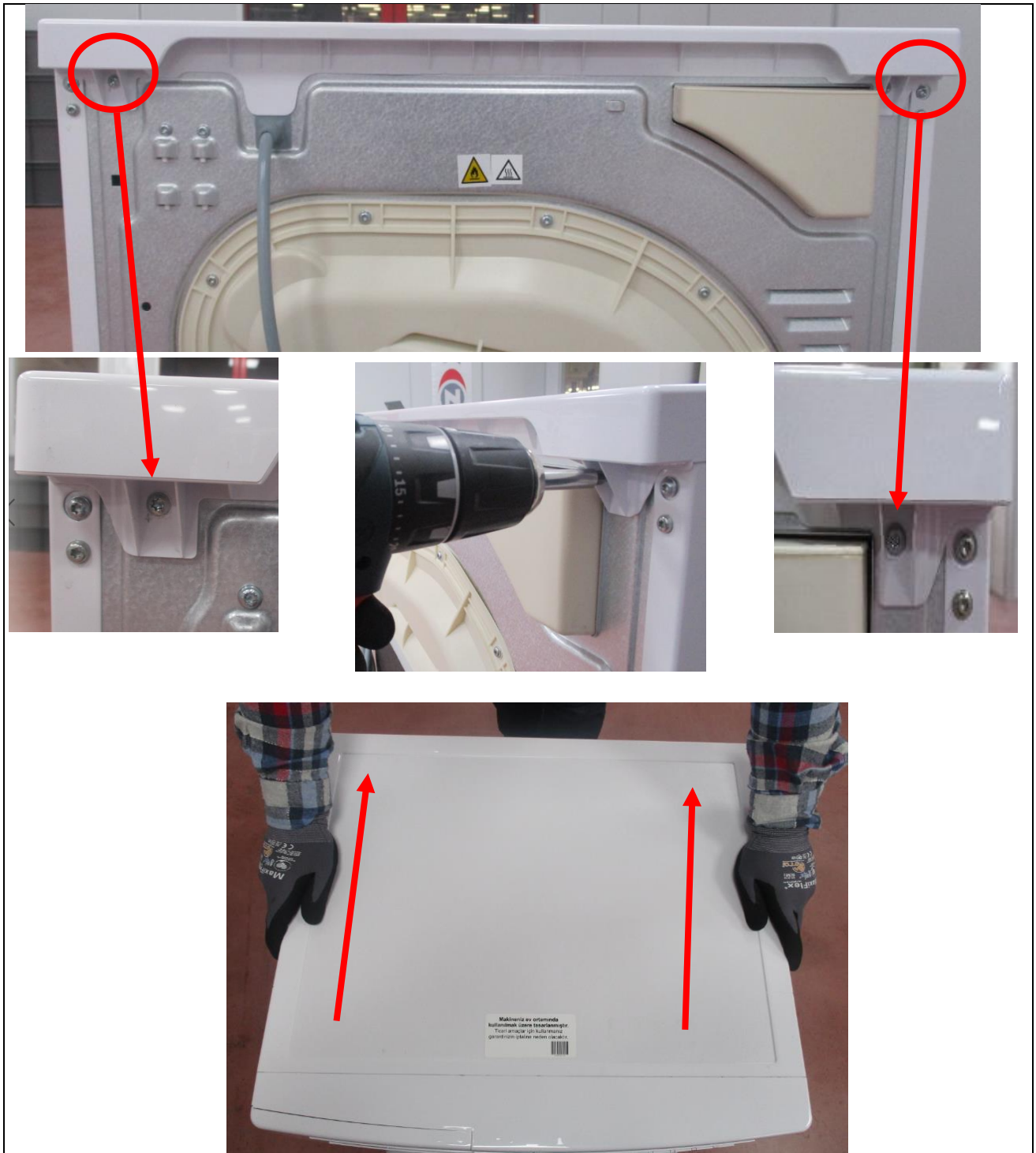

1. Remove two screws that fix the top plate at the back.
2. Remove by pulling the top plate to yourself.

6.2. Control Panel



1. Remove 2 screws from the top
2. After the water tank removed, the plastic screw in the center of the control panel should be removed.

6.3. Control Panel

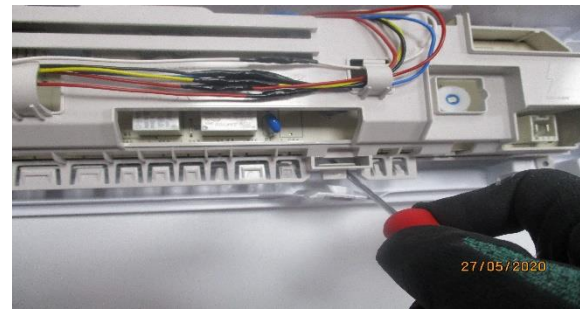
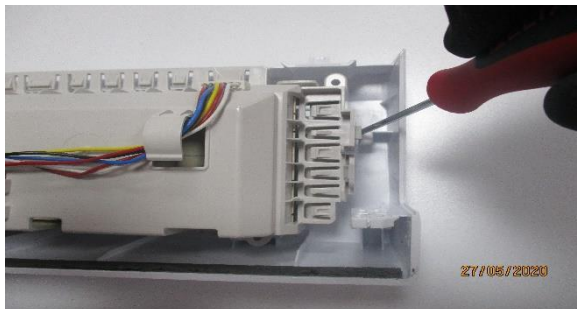
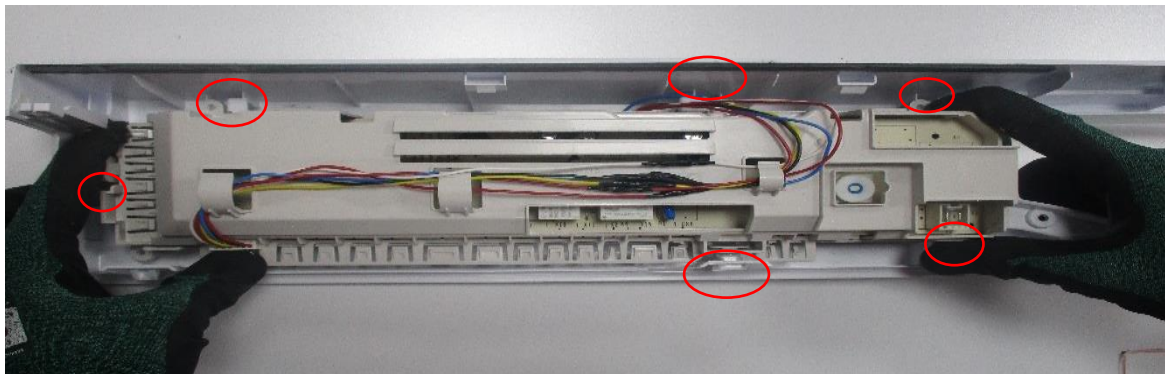

1. After removing the screws on the control panel, the control panel is removed as shown in the photo from the upper support bracket.
2. The cables on the control panel are carefully removed from the cable paths.
3. All sockets which is connected with electronic card must be removed carefully as shown in the photo.

6.4. Electronic Card

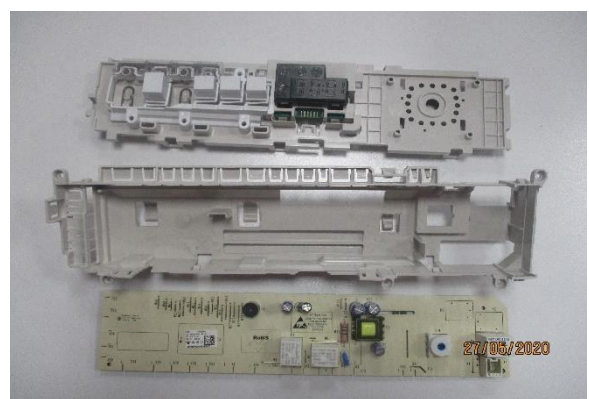
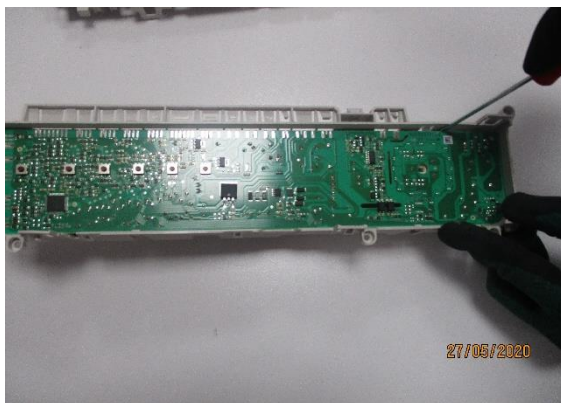
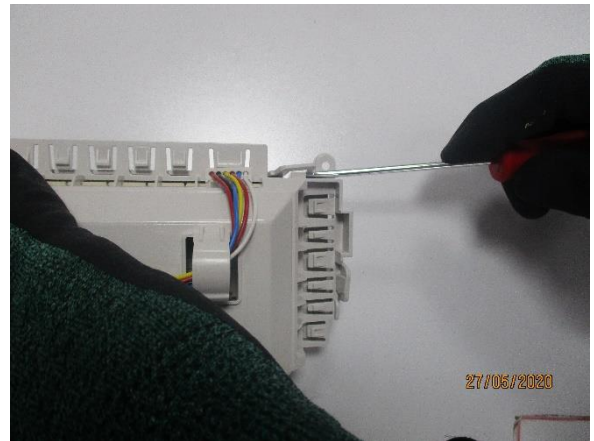
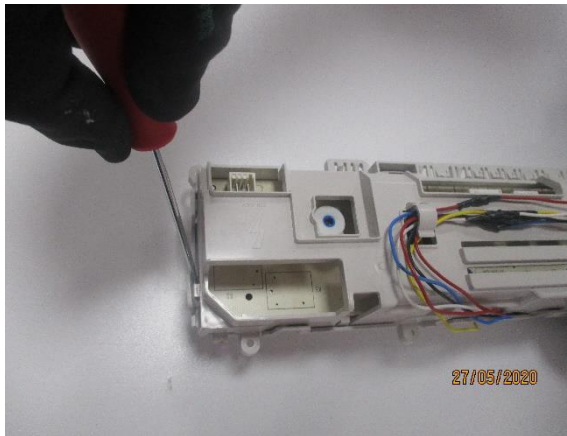
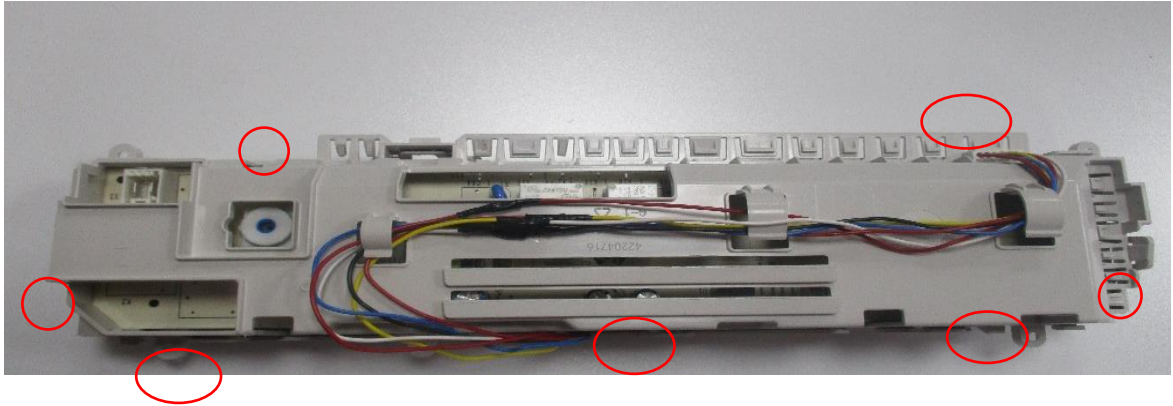

1. To remove the electronic card box (PCB box) from the control panel, it is necessary to remove 6 tabs. As shown in the photo, you can take off the tabs with thin screwdriver.
2. The PCB box is separated from the control panel.

6.5. UI Card

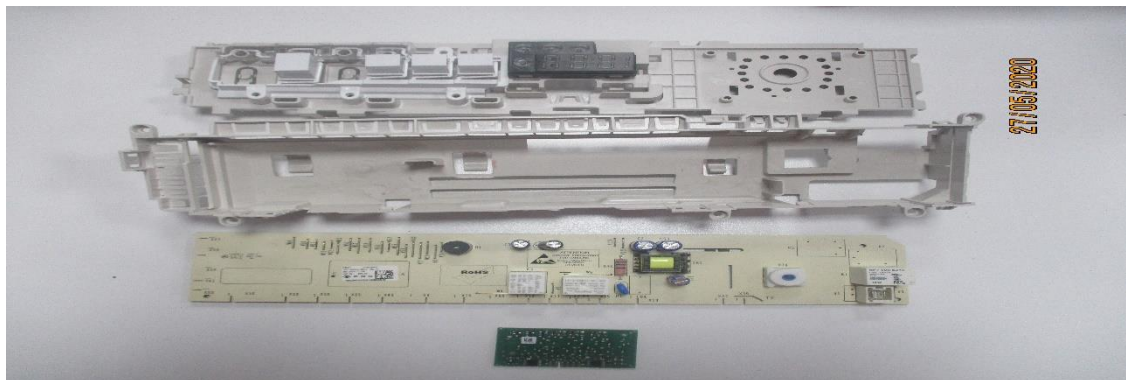
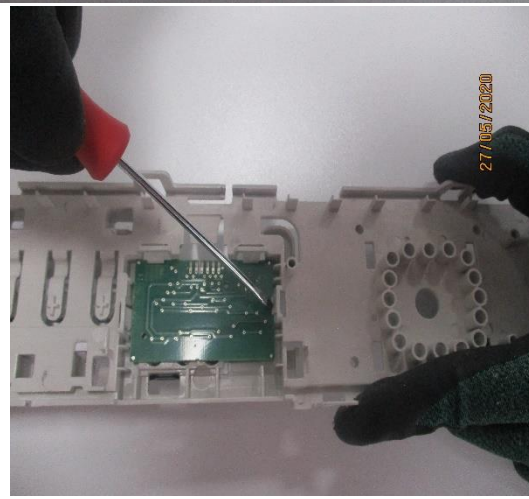
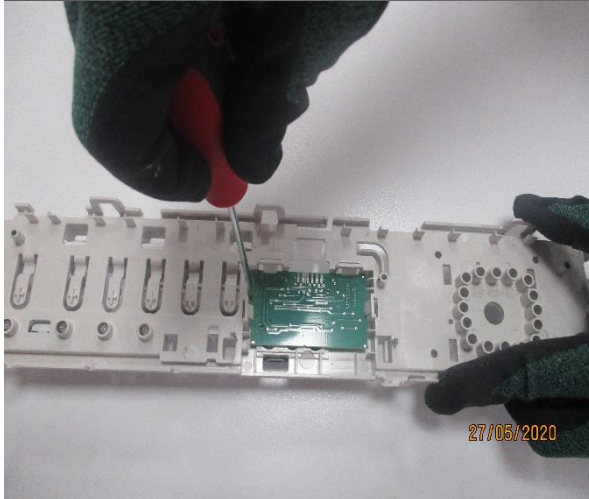
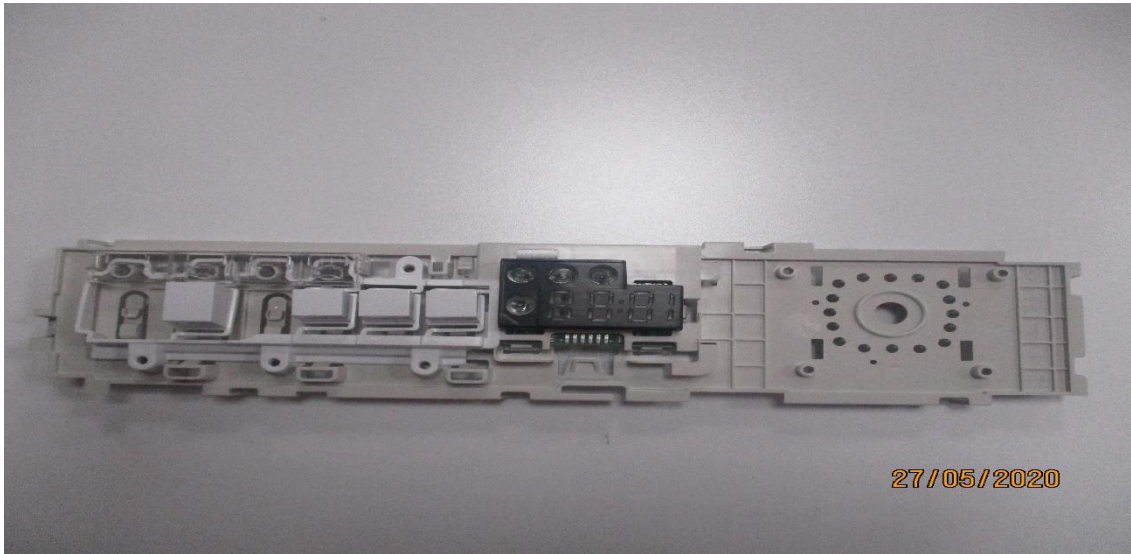

1. UI card on control panel is disassembled as shown in photo

6.6. Side Panel



1. Remove 10 screws on side panels

6.6. Side Panel



2. Remove 2 screws from front
3. It should not be forgotten to take bottom screw (2 screws)
4. Remove the side plate which is pulled out screws , by pushing up

6.7. Supply Cable

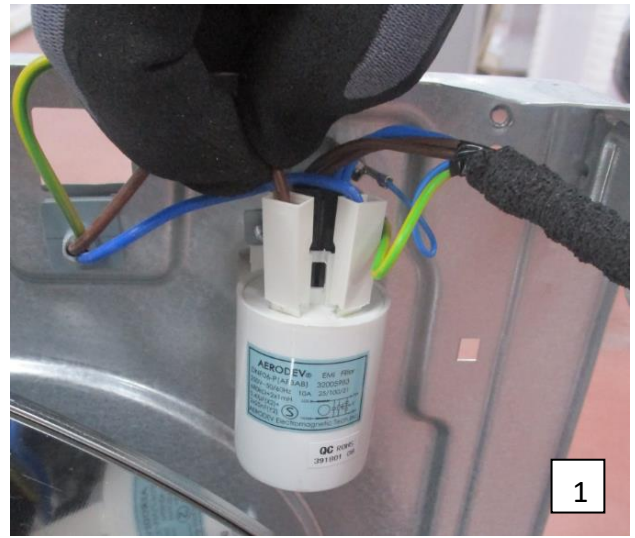

1. Remove the supply cable brown and blue cable socket.
2. Remove the terminals with tool as shown in the photo
3. Remove supply cord by pushing up

6.8. Emi Filter



1. Remove EMI filter sockets
2. Remove the terminals with tool as shown in the photo
3. Remove the EMI filter which is fixed with 2 screws to the rear panel

6.9. Rear Cover



1. Remove all screws shown in the photo.

6.10.Pump

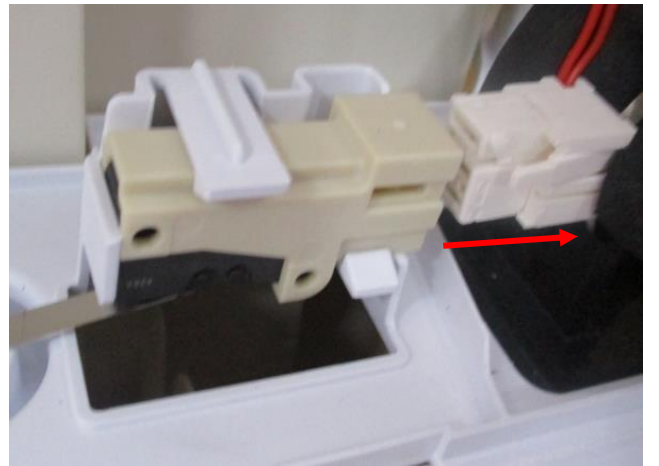
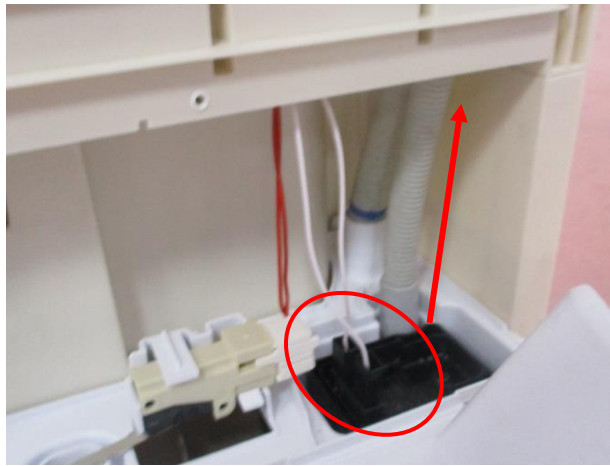

1. Remove the screw on pump cover
2. After opening the pump holder plastic cover, Remove 2 hoses that is connected with pump.
3. Remove aqua switch and pump socket.
4. Remove the pump holder plastic from basement plastic as shown in the photo

6.10.Pump



5. Push the pump from plastic.
6. There is a float in the pump housing as shown in the photo.

6.11.Process Fan



1. Hold the fan as shown in the photo.
2. First remove washer and nut then remove the process fan.

6.12. Rear Panel

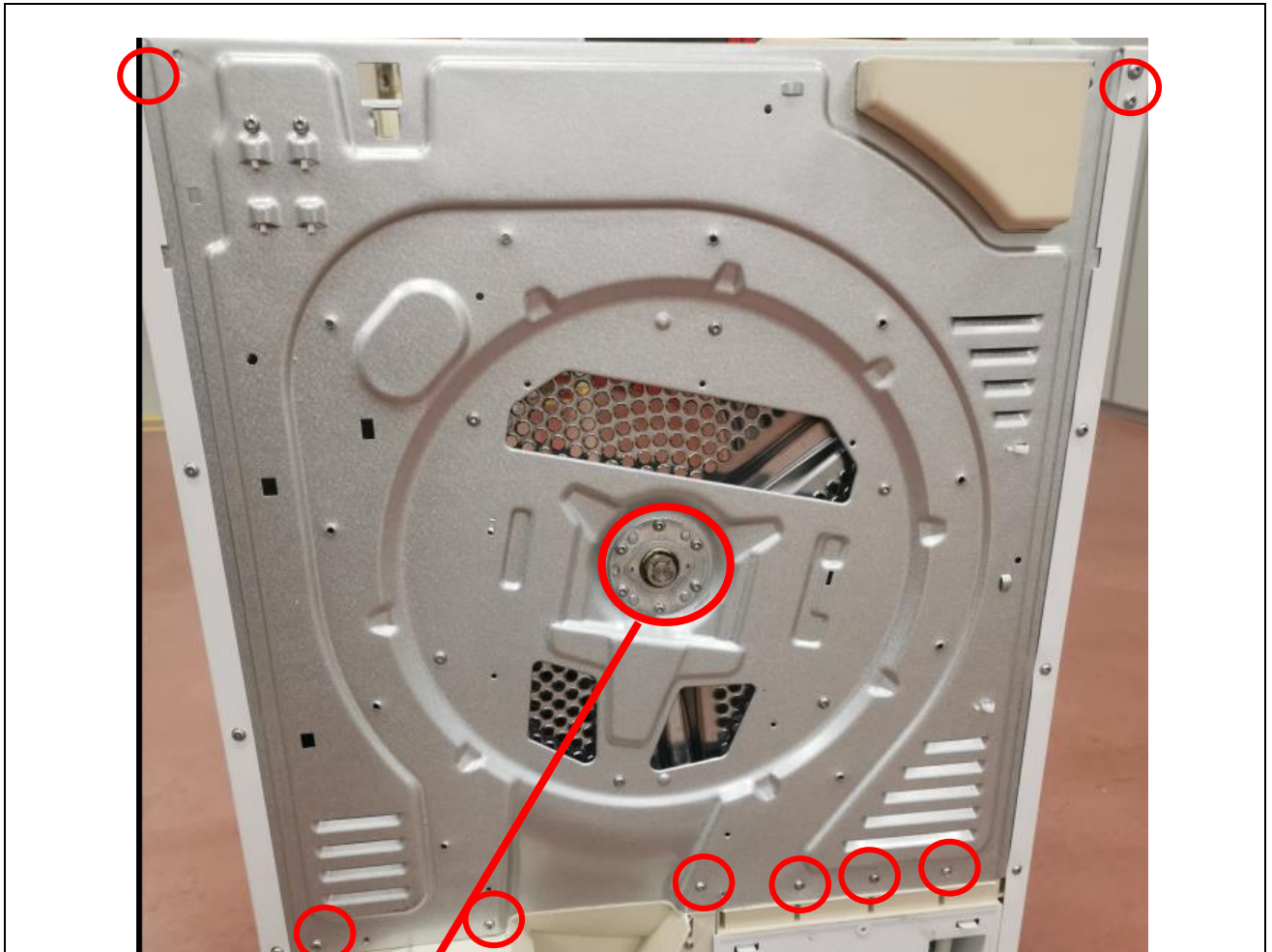

1. Remove segment on rear panel.
2. Remove 8 screws from panel

6.12. Rear Panel

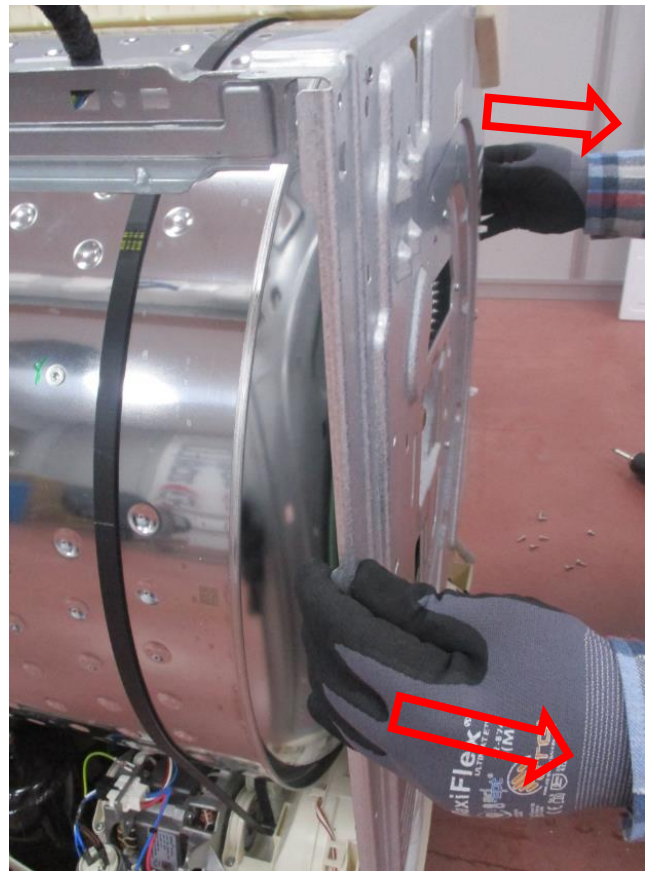
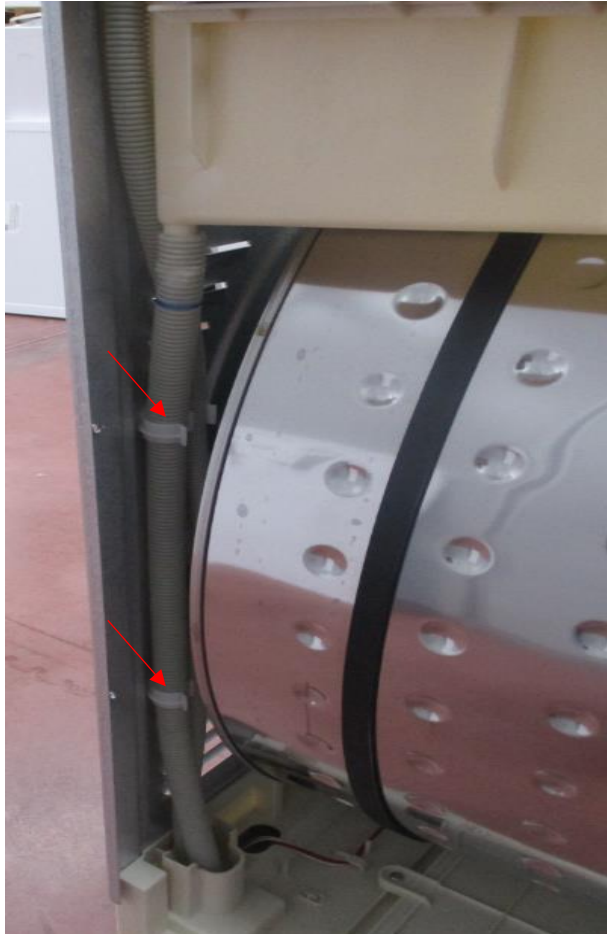

1. Remove hoses from rear panel
2. Remove the rear panel by pulling to yourself.

6.13.Rear Isolation Group

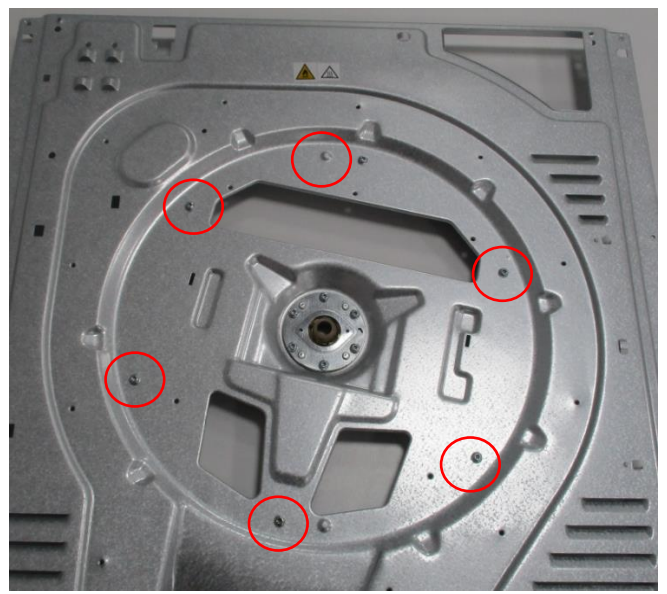
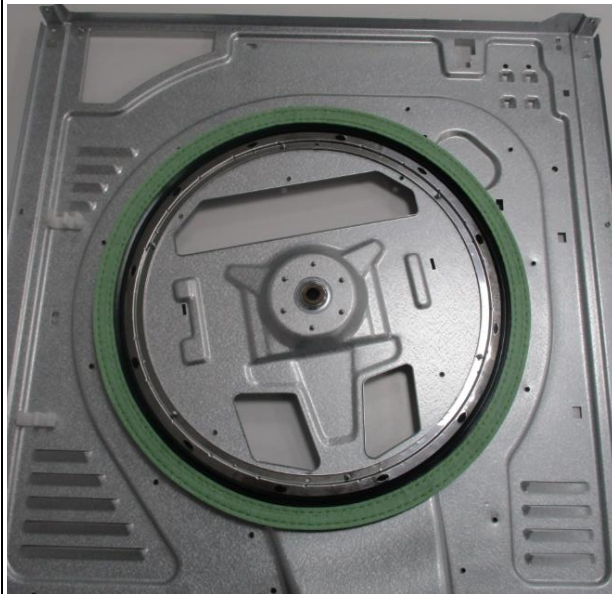

1. For disassembling the rear Isolation group on rear panel, screws are shown in the photo should be removed.

6.14. Rear Bearing Group



1. For disassembling the rear bearing group on rear panel, screws are shown in the photo should be removed.

6.15. Water Tank Housing

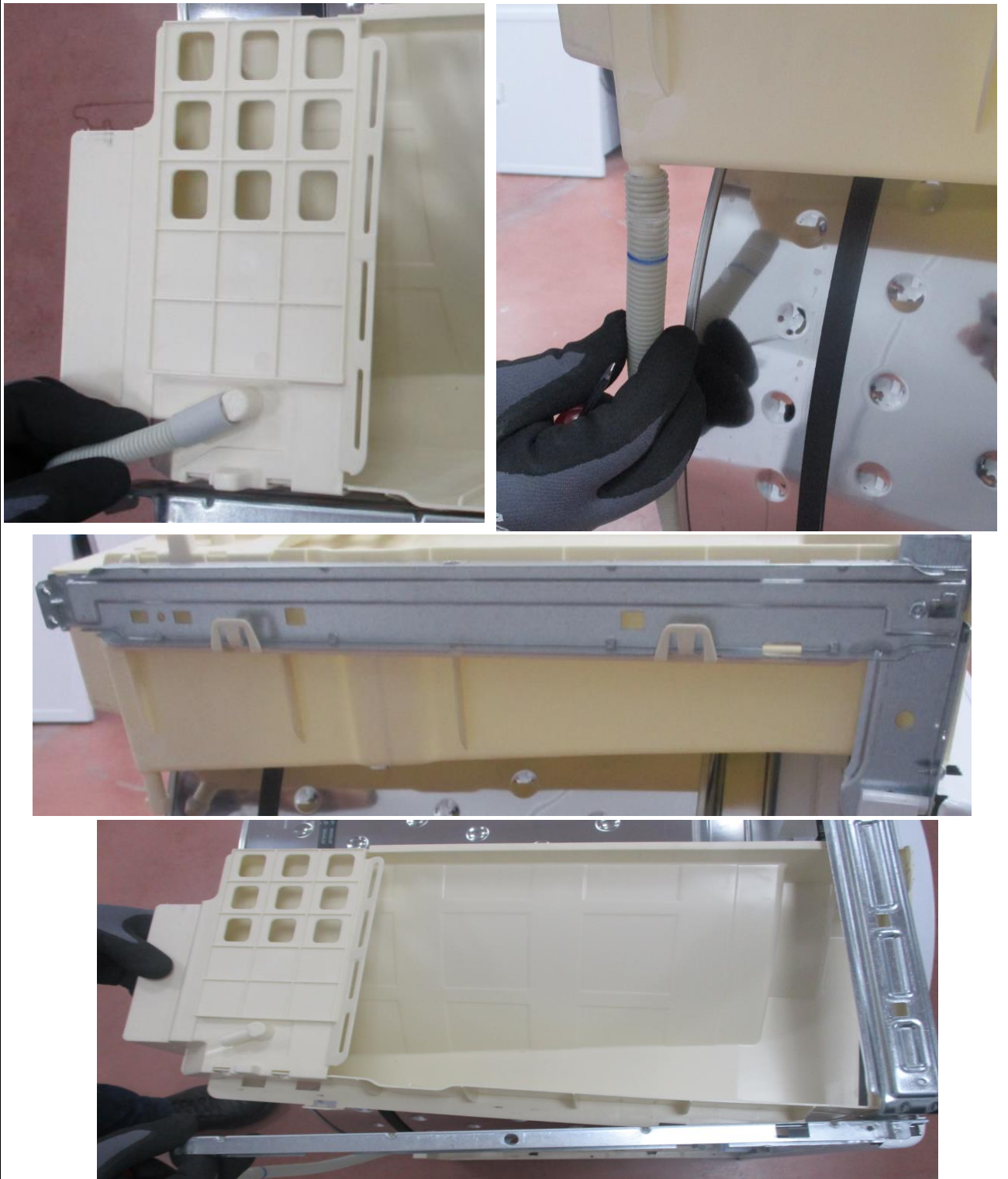

1. Remove 2 hoses from water tank housing.
2. Remove the water tank housing clips.
3. The water tank housing is removed as in the photo.

6.16. Drum

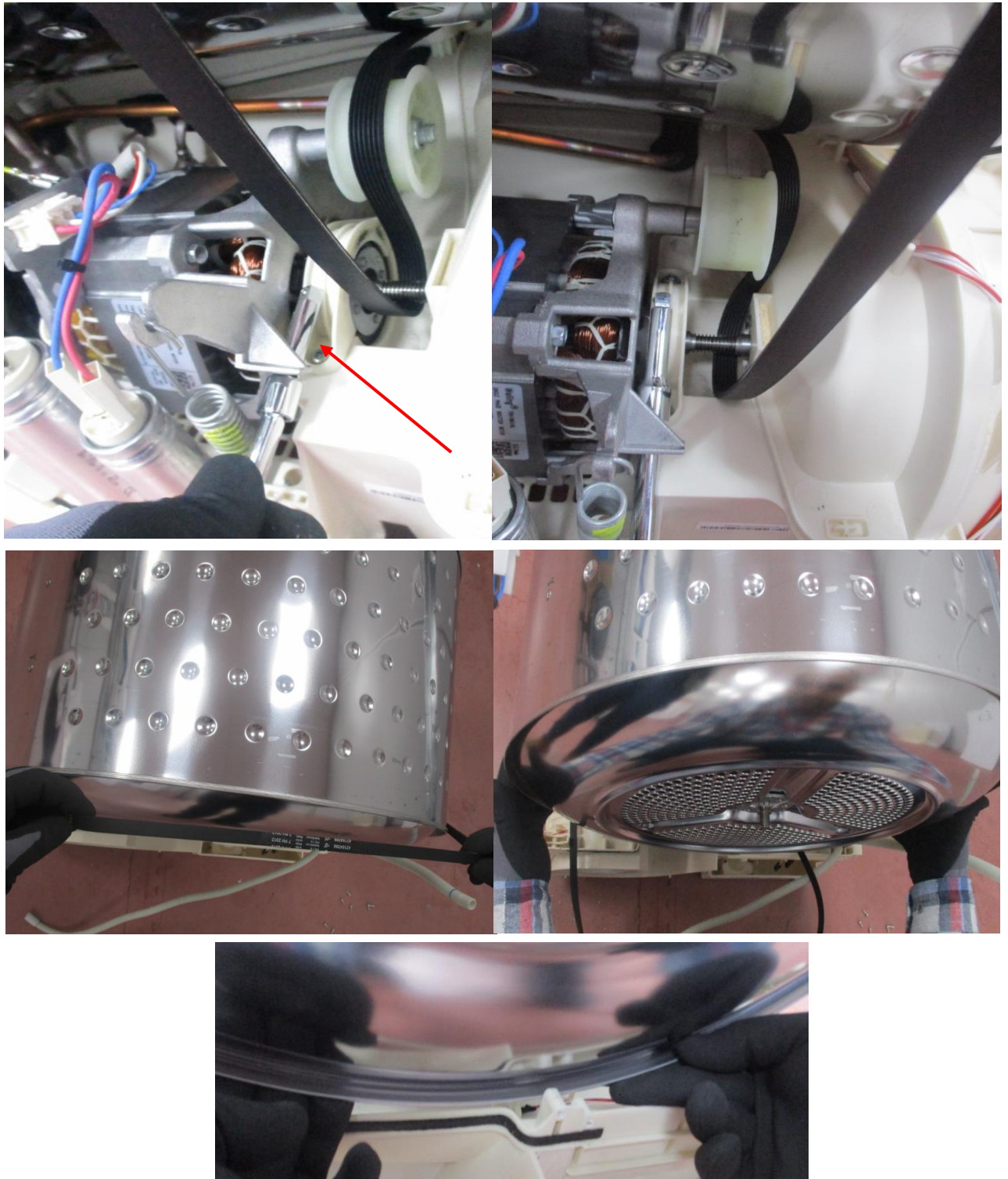

1. Motor should be moved up to prevent to press spring. So, belt will be released as shown in the photo.
2. Remove the belt on the drum
3. Pull up the drum to separate with basement plastic. Then, pull back to remove.

6.17. Motor

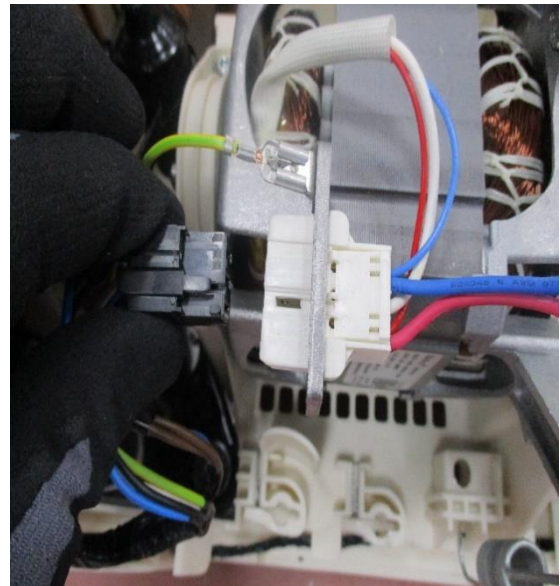
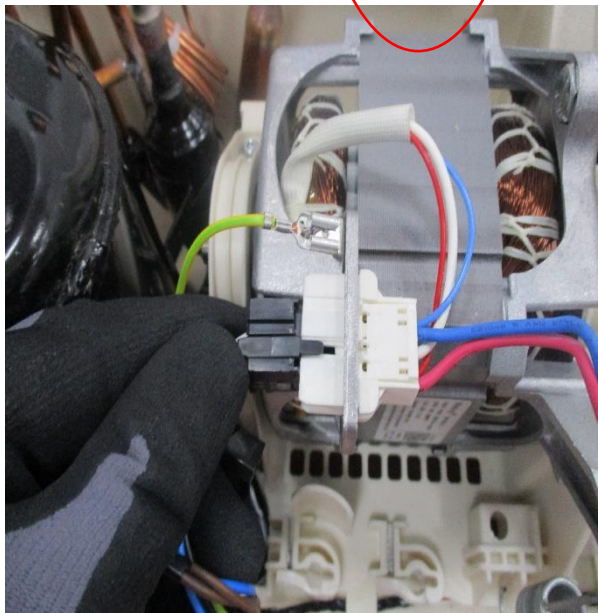
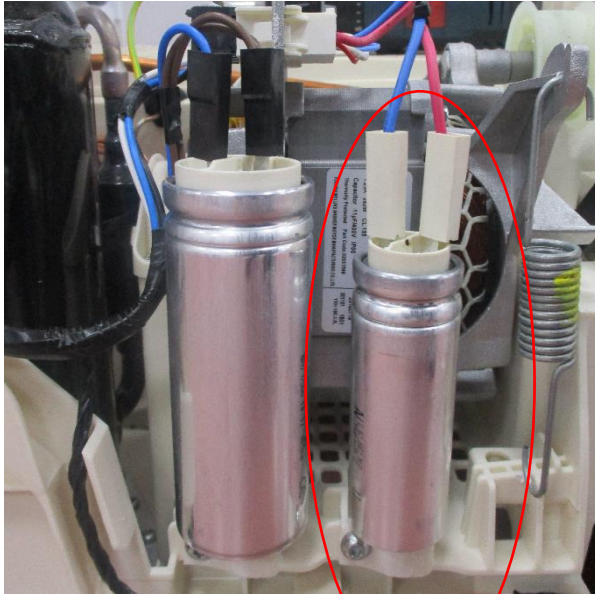

1. Remove capacitor sockets and other sockets from motor.

PS: before removing the motor, process fan should be removed.

You can apply the same instruction to change the belt

6.17.Motor

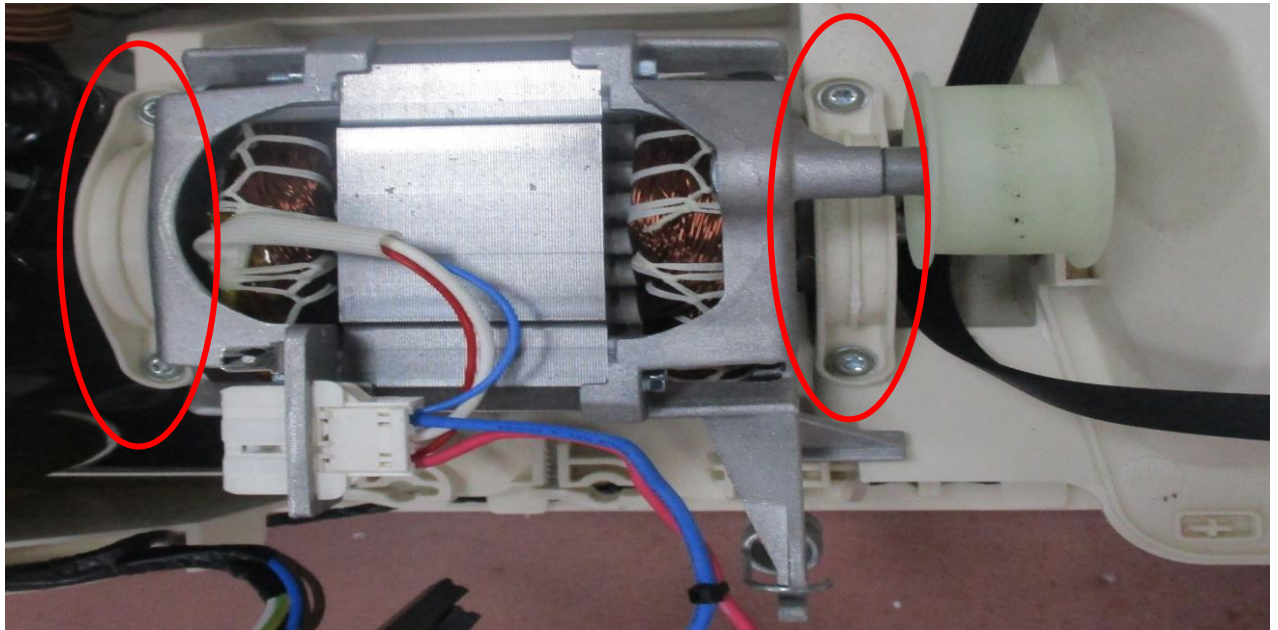

2. Remove 4 screws from motor fixing plastic
3. Take the motor from basement plastic as shown in the photo.

6.18. Capacitors



1. Remove all sockets from motor.
2. Remove the screw on bottom of capacitor then disassemble the capacitor
3. The capacitor is removed by turning.

6.19. Belt

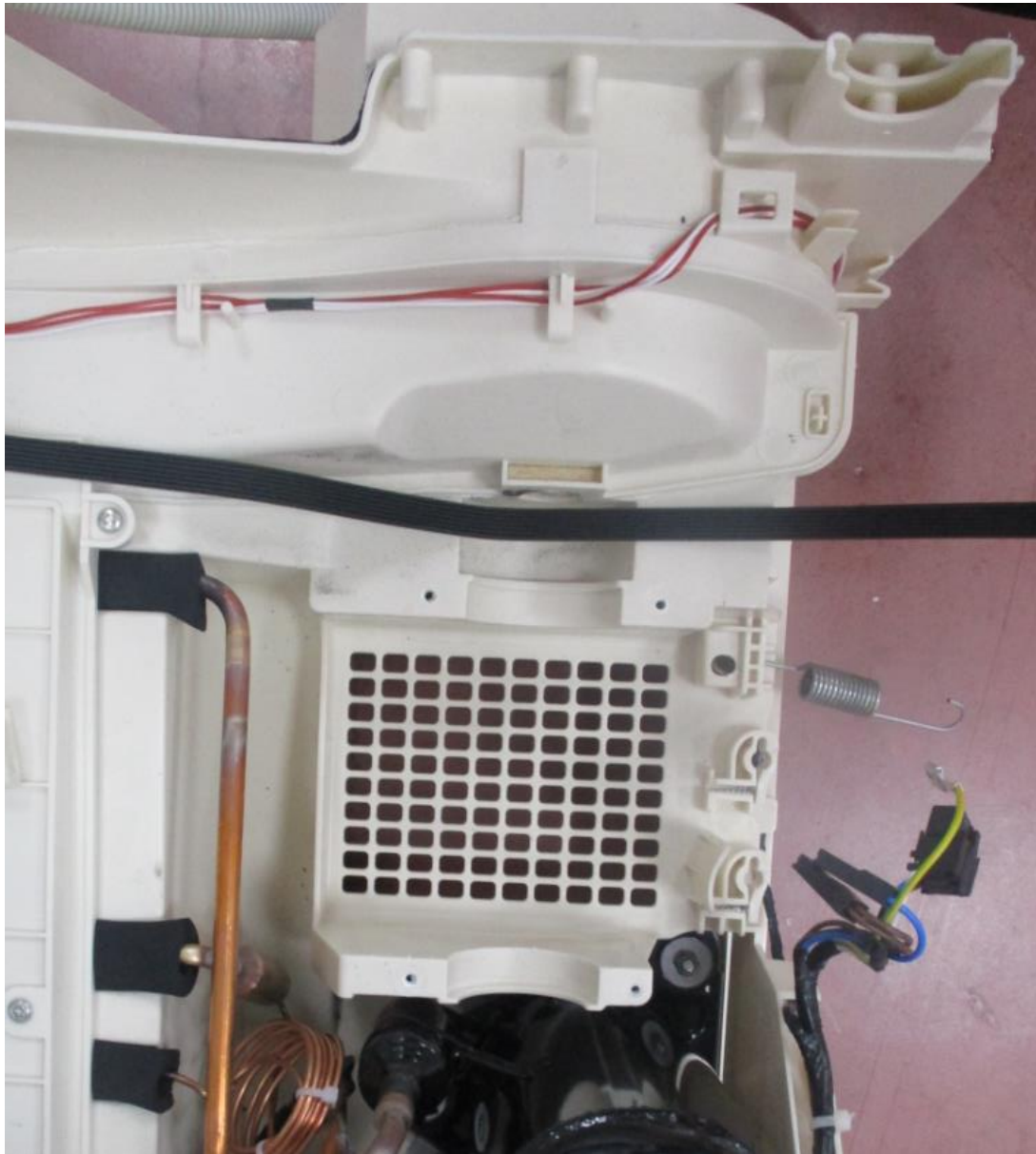

1. After you should remove drum and motor than change the belt.

6.20. Humidity Sensor



1. Remove 5 screws from humidity sensor plastic.
2. Remove the humidity sensor cable as shown in photo.

6.21. Door latch

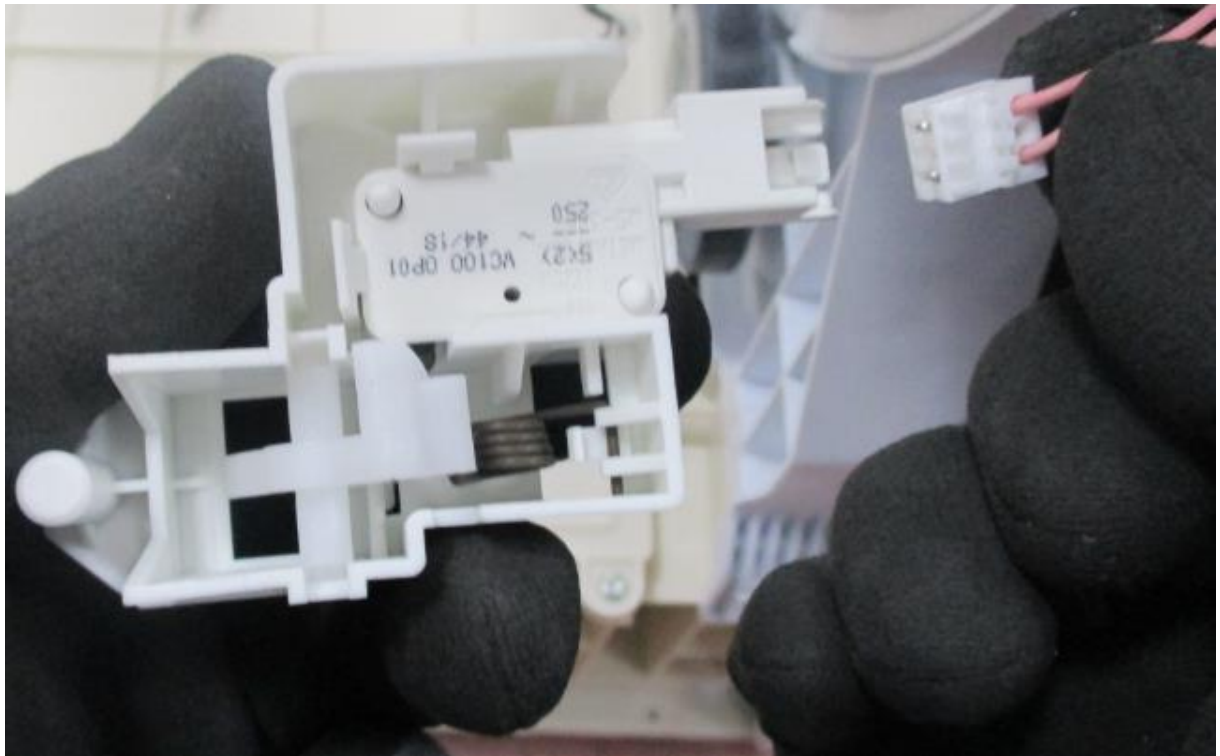
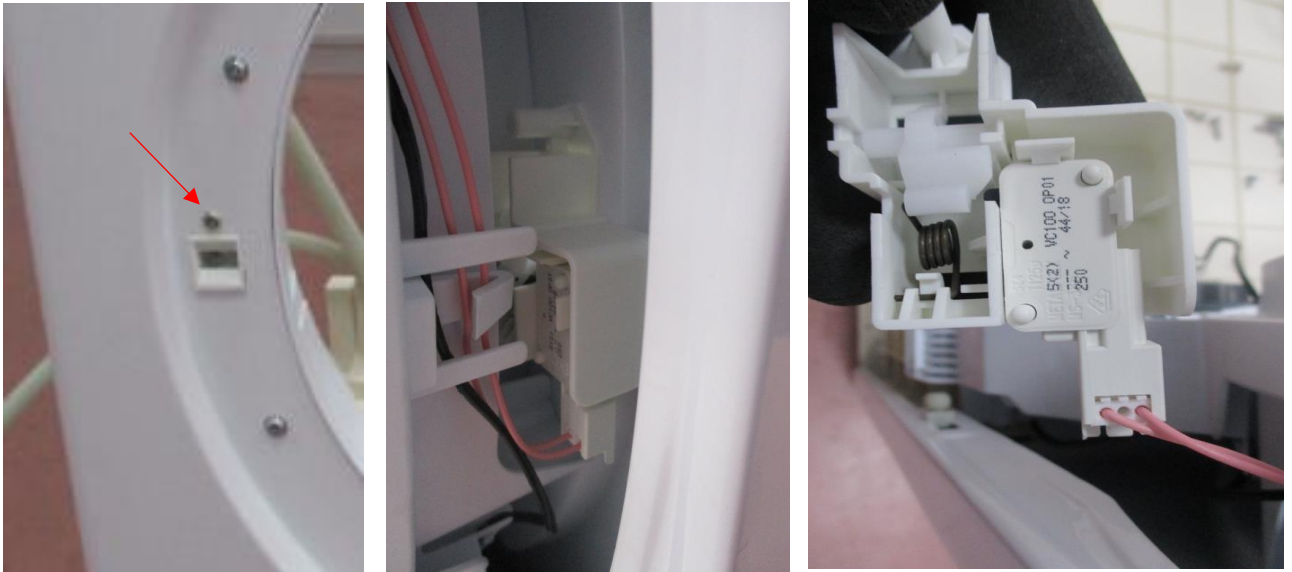

1. Remove door latch screw from front panel.
2. Separate the door latch socket from door latch as shown in the photo.

6.22. Plinth



1. Remove the plinth screw
2. Remove the plinth as shown in the photo

6.23. Cooling Fan

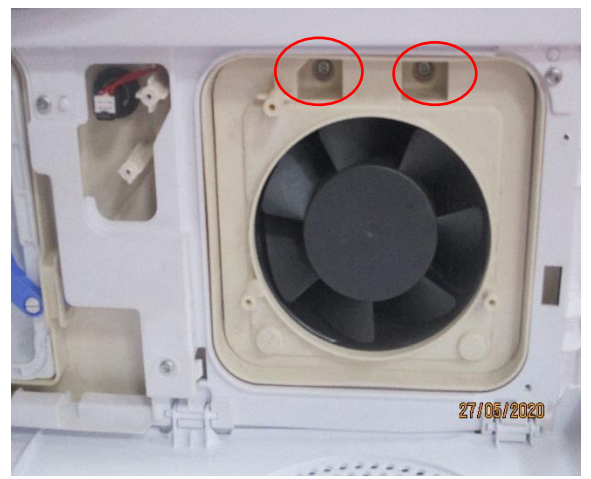

1. Remove screws on cooling fan fixing plastic
2. Remove the cooling fan fixing plastic as shown in the photo.
3. Disassemble the cooling fan by removing the fan screws and fan ground wire.

6.24. Plinth Cover



1. Remove 2 plinth pin on Plinth cover.

6.25. Door



1. Remove 2 screws that fix the door.
2. Pull the door by lifting up.

6.26. Drum Bearing Wheel



1. Remove wheels as shown in the photo

6.27. Drumlight

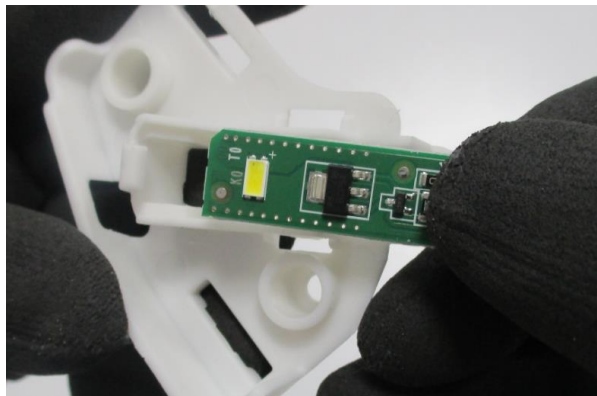
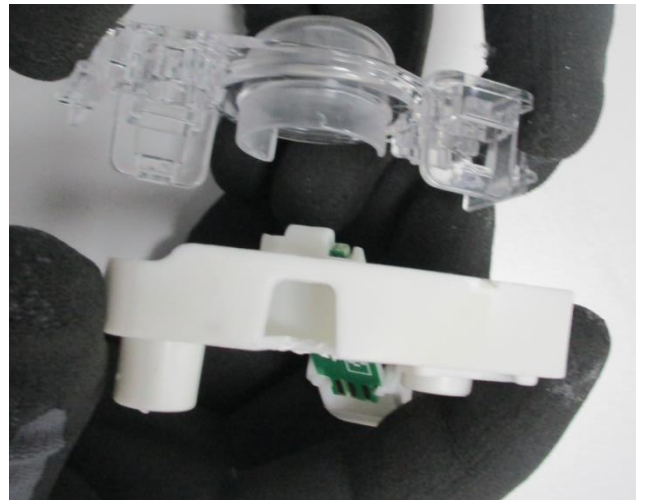

1. Remove Drumlight group from Front Shield
2. Remove the drum light socket.
3. Remove the drum light card.

6.28. Front Panel



1. Remove 16 screws on the front panel
2. While removing the front panel, the cable of the door latch must also be removed.

6.29. Door NTC



1. Remove the socket from NTC sensor on the basement plastic.
2. Remove the NTC from basement plastic by hand or tool

6.30. Side Bracket



1. Remove cable holder plastic clips shown in the photo. (For right side bracket)
2. Remove screw from bracket which is fixing side bracket and top bracket. (Rear panel was removed before.)

6.31. Front Shield

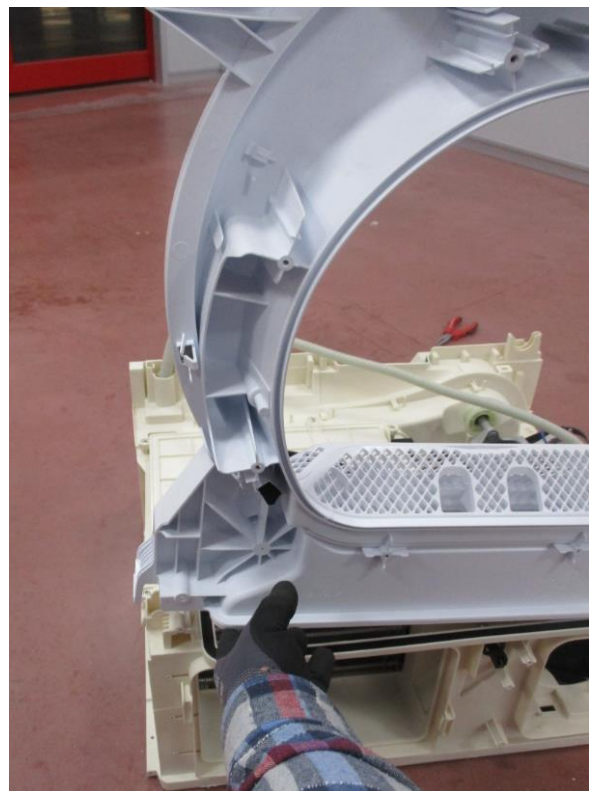
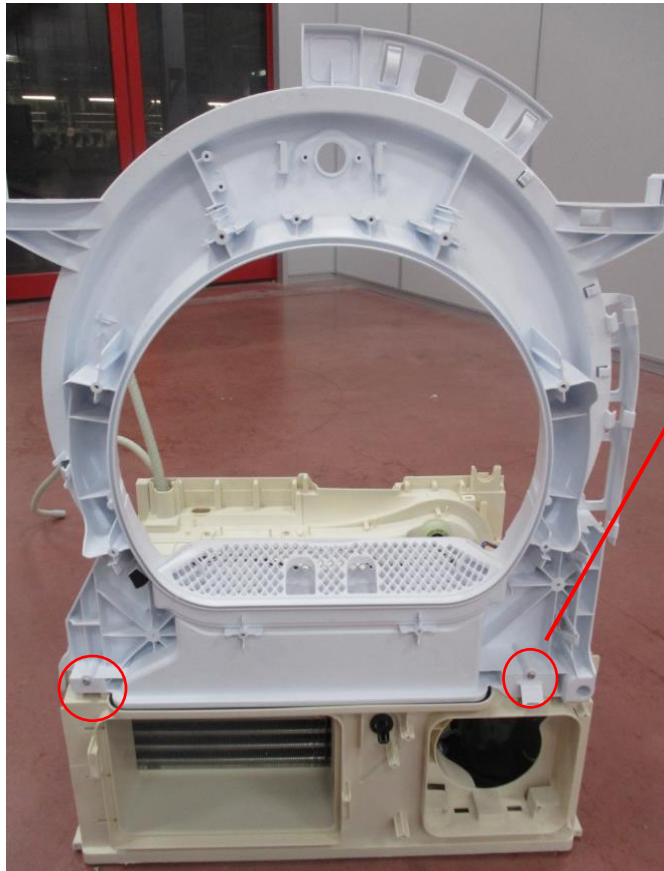

1. Remove 2 screws in the bottom.
2. Open clips on the left side.
3. The front shield should be lifted as shown in the photo.

6.32.Front Isolation Foam

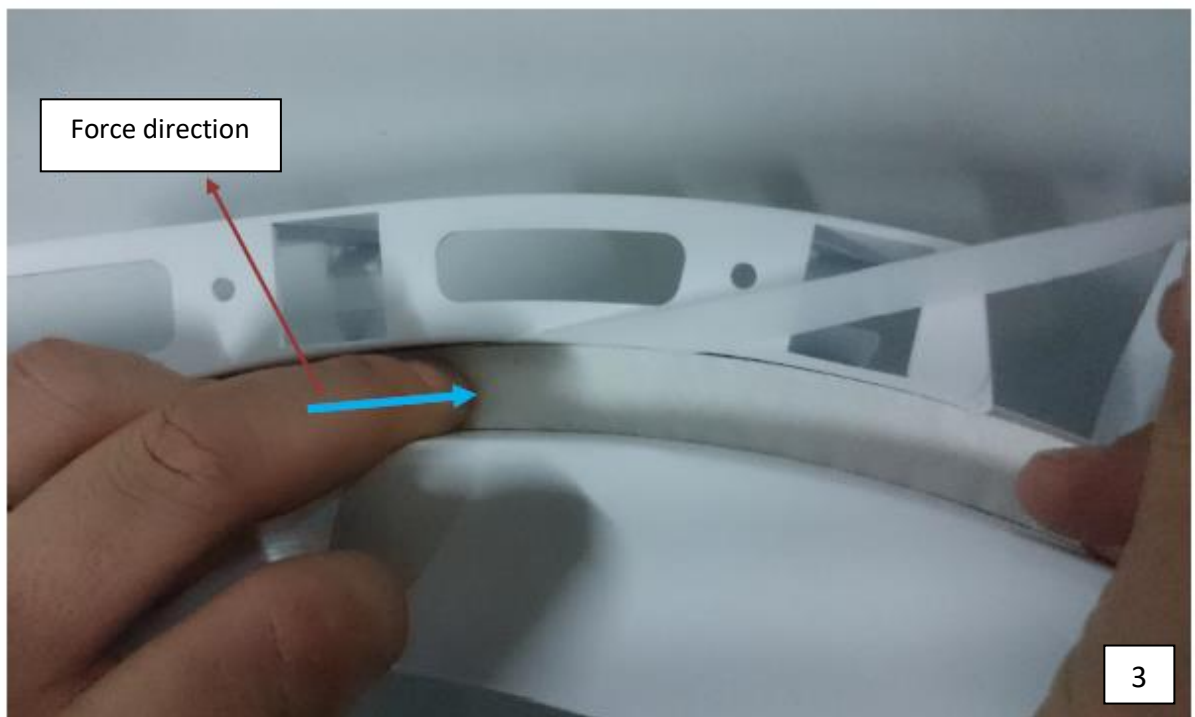
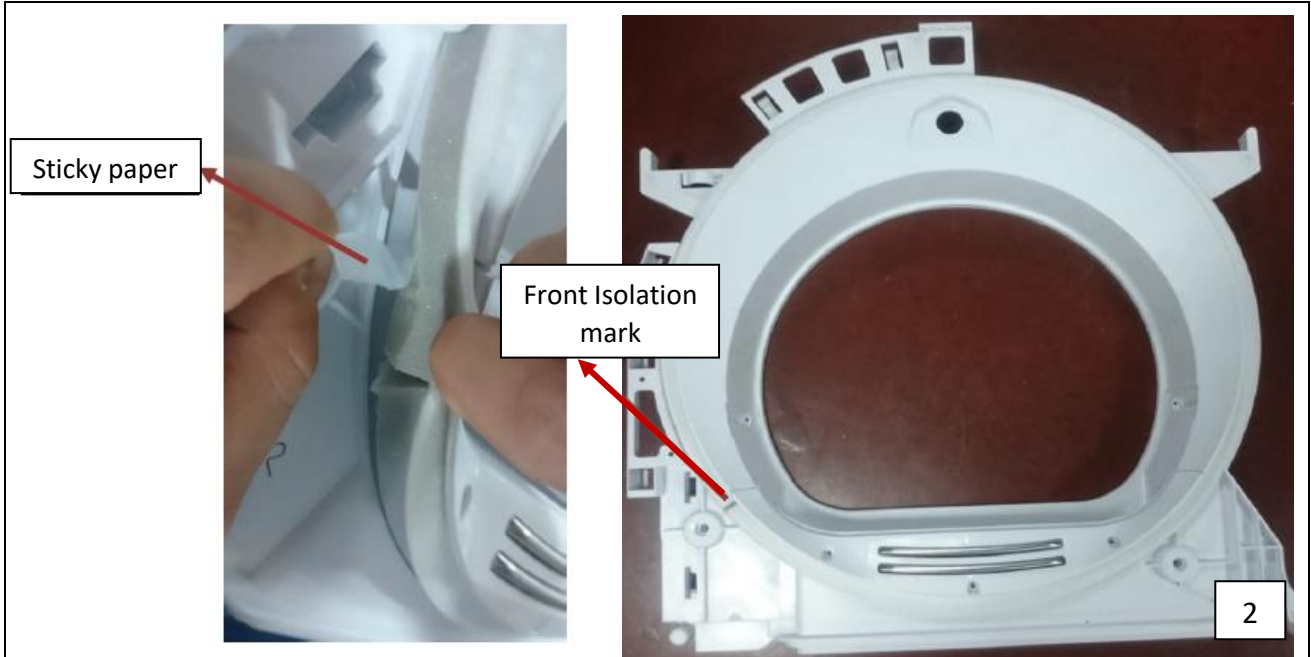

1. It is important to install the new felt correctly after it has been removed from the slot at the front shield.
2. Before Sticky paper is opened, front isolation foam should be placed to slot on front shield. Front isolation foam mark should be on left bottom of front shield.
3. Stick the foam on front shield as shown in the photo.
4. Isolation should be centered on slot

6.33. Cable Group

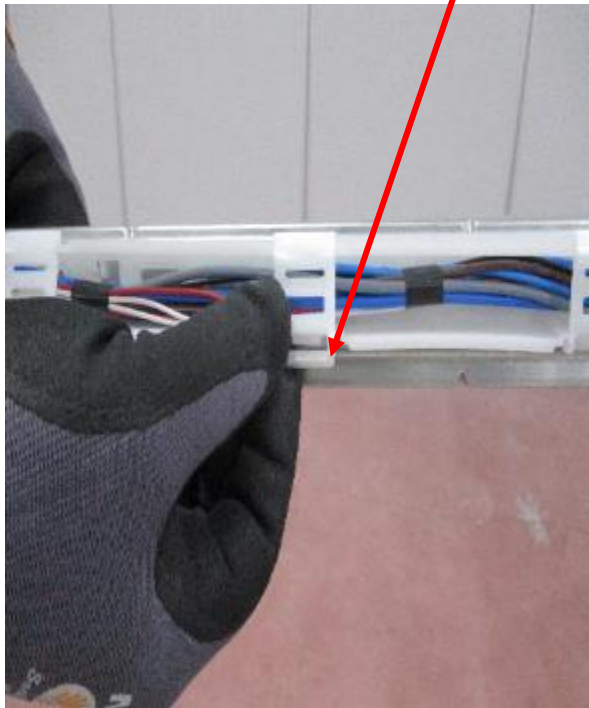
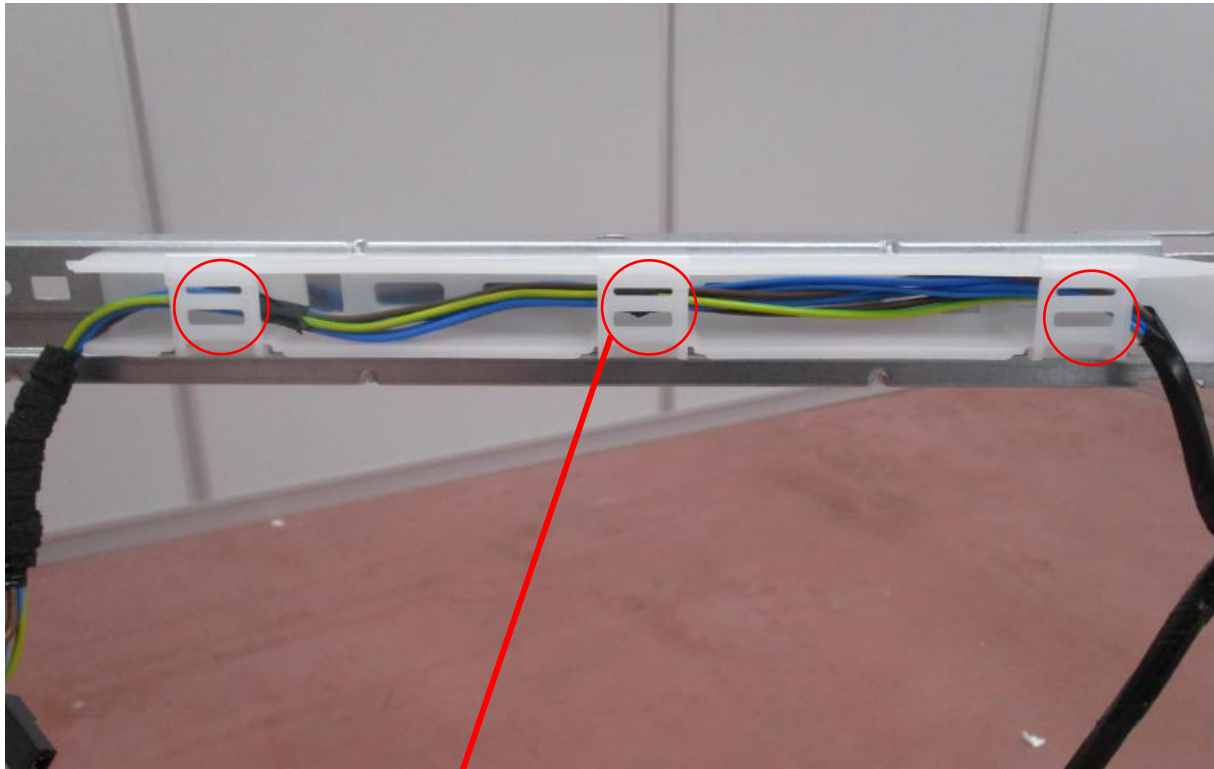

1. Open the cable holder plastic clips on side bracket.
2. Remove cable holder plastic fixing clips as shown in the photo.

6.34. Cable Group

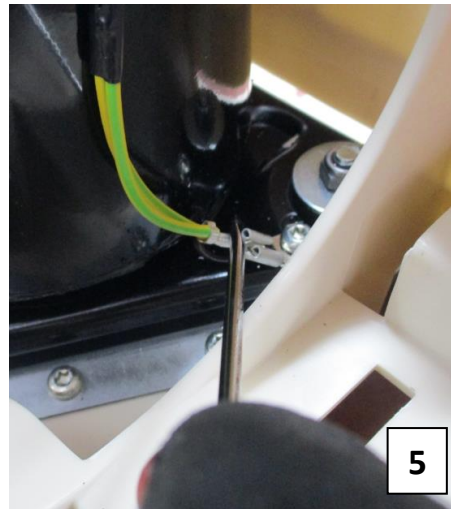
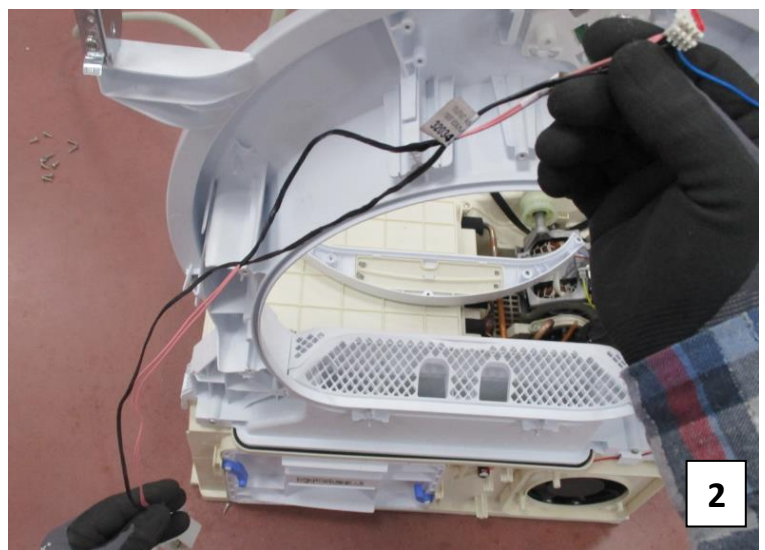
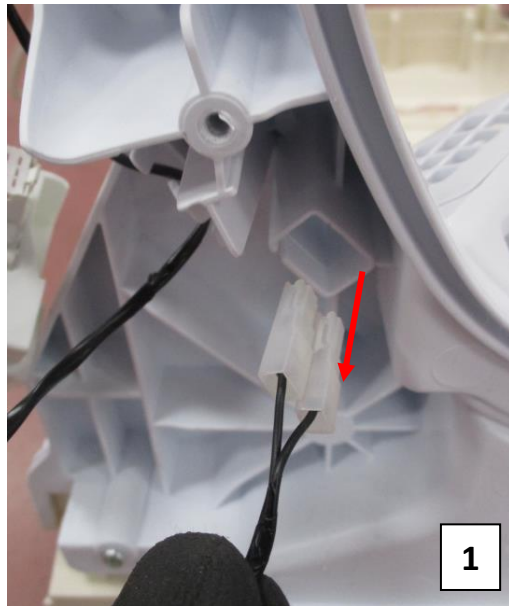

1. Humidity Sensor Cable
2. Door Latch Socket Cable
3. Cable Group of Front Shield

4. Compressor NTS Socket
5. Compressor Ground Cable
6. Compressor Socket

7. 7. COMPONENT SPECIFICATIONS AND MEASUREMENTS

7.1. Motor

The dryer has an asynchronous motor. In the photo on the right, the socket on the motor are shown to be measured by multiple counters. It is driven with triac via the electronic card (to give energy) and relay (for direction control).

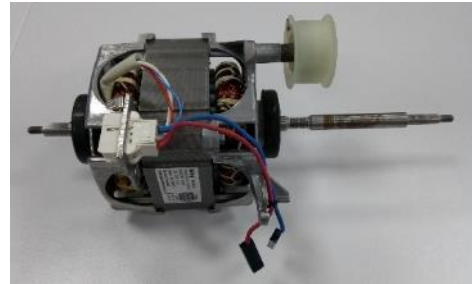

Technical Features

Type: single-phase asynchronous motor
 Power: 200 W (Unloaded drum)
 Main windings: 21.5±7% (20 °C temp.)
 Aux windings: 19.5±7% (20 °C temp.)

Motor speed : 2750 rpm (Unloaded drum)
 Drum speed : 52 ± 2
 Capacitor value : 11 µF ± %5

Component Test

- Check whether the motor cable is connected to the motor connector.
- Check the connection of the capacitor cables
- Measure the resistance values and check the capacitor values
- Check whether it is working by connecting via the terminals 1 and 2 (Blue-White) connection
- If it is working, revolution of the drum is measured in unloaded state.

The terminals 1-3 of the motor should be connected with capacitor

Resistance measurement of main winding: Terminal 1 -2 (Blue-White) is measured.

Resistance measurement of aux winding: Terminal 3 -2 (Red-White) is measured.

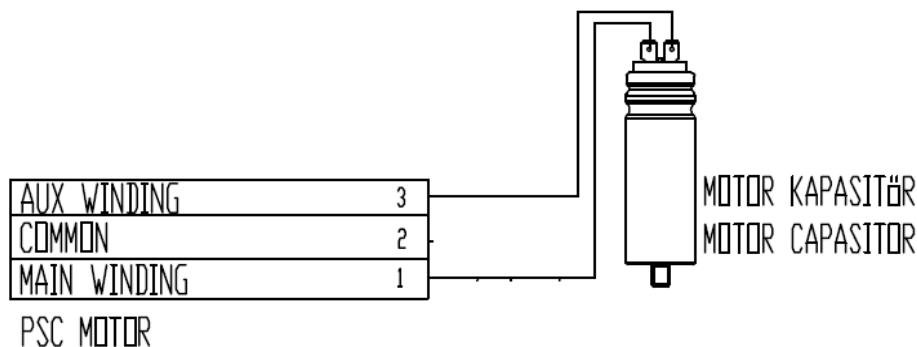

7.1.1. Motor Measurements

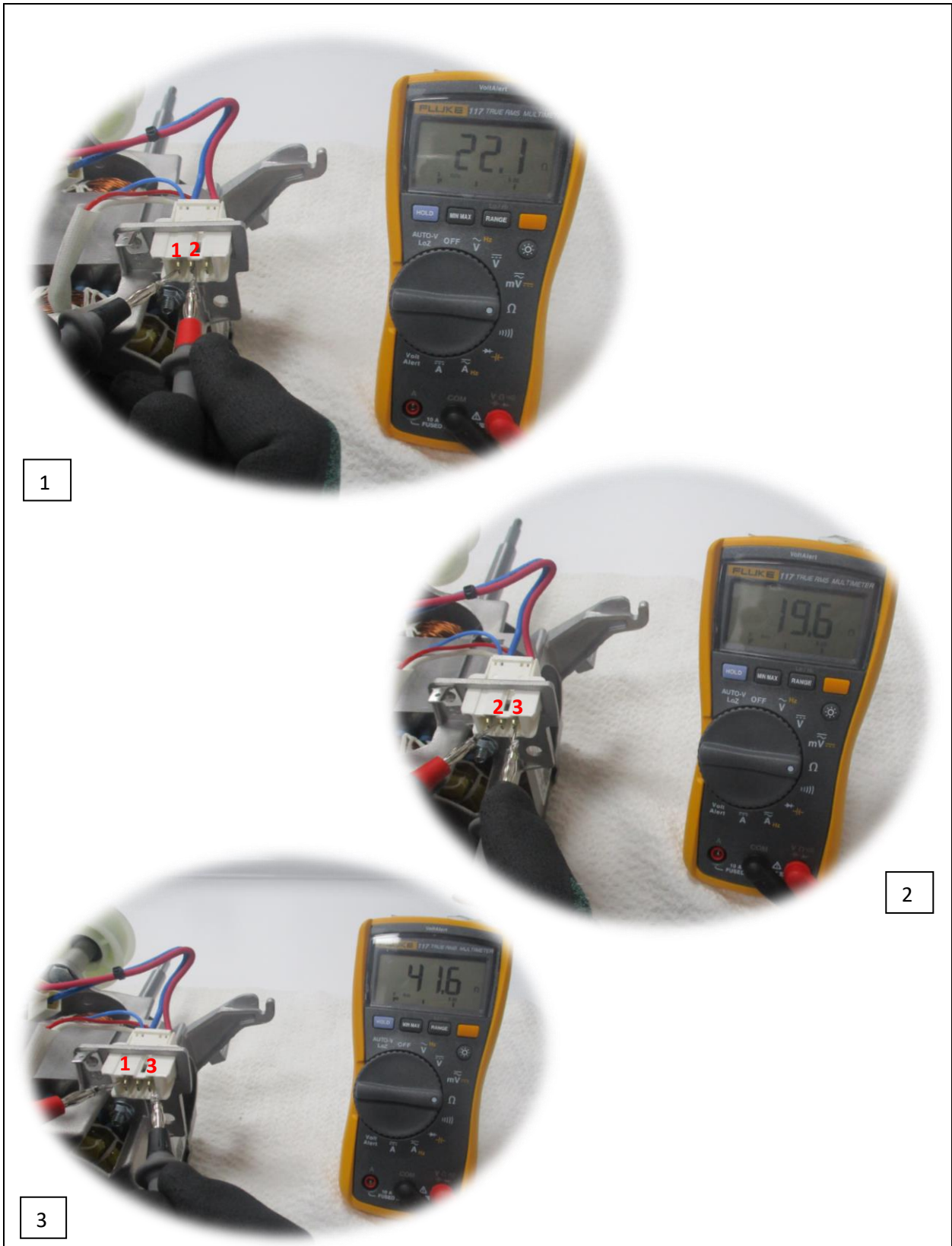

7.2. Pump

In Tumble Dryer models, the pump is used to transport the water that accumulates in the condensation chamber to tank in the drawer area. One triac is measured on the electronic card.



Technical Features

Resistance : $764 \pm 10\%$ ohm
Voltage: 220-240 Volt
Frequency: 50 Hz

Input Power : 13W max

Component Test

- Check the connection of the pump connector
- Check the pump resistances
- Check whether pump is working, by feeding externally
- If the pump is working, the water in the tank is unloaded by running the pump Then, Unload 500 ml of water from water tank to pump reservoir and check whether water is pumping.
- While pump is working, if water is not reached into water tank, hoses should be checked.

7.2.1 Pump Measurements

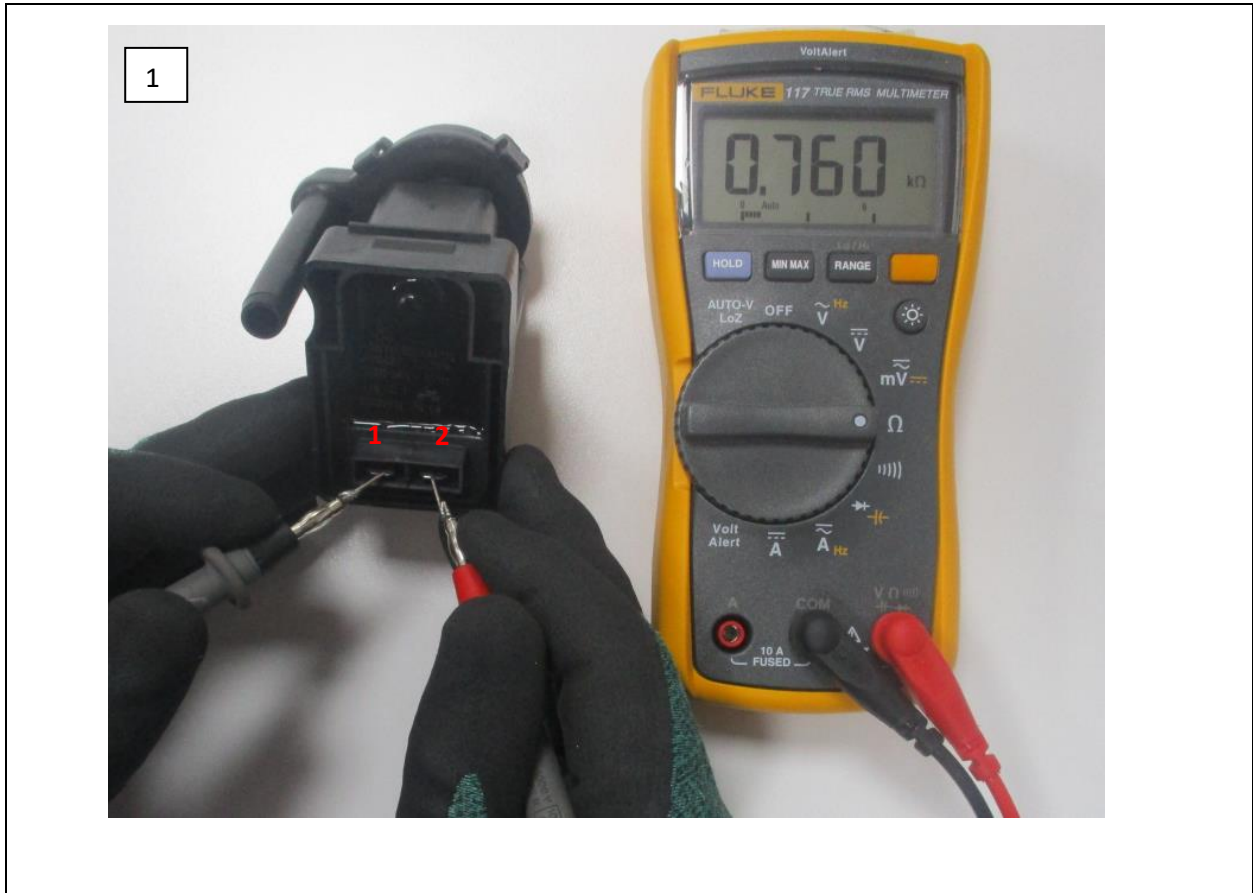

7.3. Electronic Card

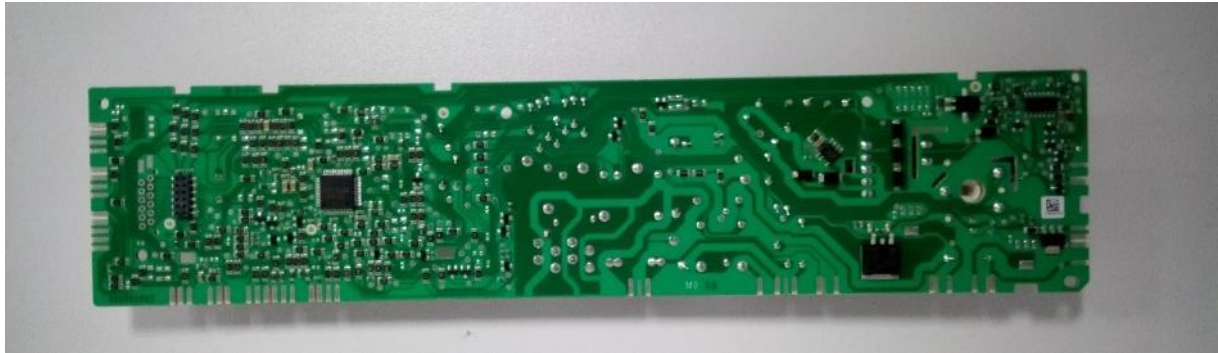

Technical Features

Electronic card is single sided printed circuit board and CEM-1 material

7.4. Door/Compressor NTC Sensor

Two NTC sensors are used. The NTC resistance decreases when the temperature rises.



Technical Features

Door NTC Resistance : 12 k Ω (Measured from IDC connected to electronic card)
Compressor NTC Resistance : 12 k Ω (Measured from IDC connected to electronic card)

Component Test

- Resistance is measured from IDC connected to electronic card

7.4.1. Door NTC Sensor Measurements

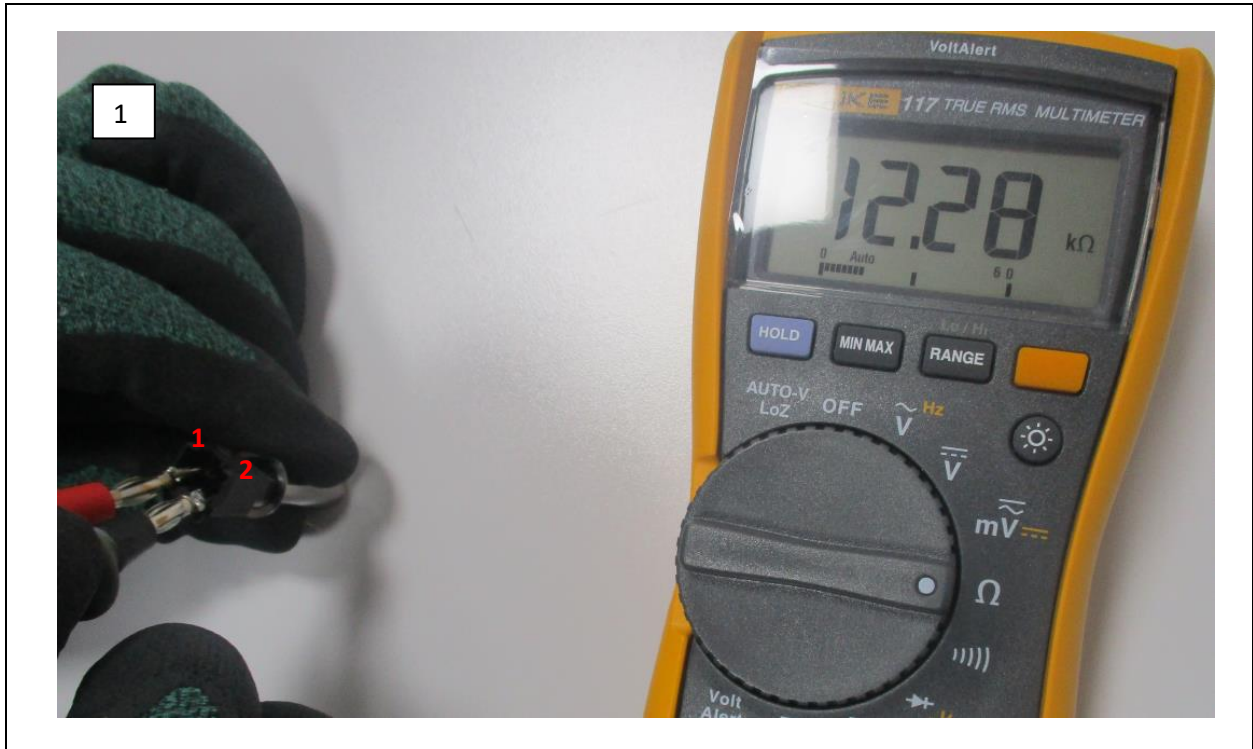

7.5. Compressor

The dryer has an compressor with an asynchronous motor. In the photo on the right, the terminal on the compressor are shown to be measured by multiple counters. It is driven with relay via the electronic card (to give energy) and relay drive the compressor only one direction.



Technical Features

Type: single-phase asynchronous motor
 Power: 350 W (Unloaded drum)
 Main windings: 9.3±7% (25 °C temp.)

Aux windings: $8.75 \pm 7\%$ (25 °C temp.)
Motor speed : 2928 rpm (Unloaded)
Gas Type: R290
Capacitor value : $20 \mu\text{F} \pm 5\%$
Compressor Capacity: $7.8 \text{ cm}^3/\text{rev}$

Component Test

- Check whether the compressor cable is connected to the compressor terminal.
- Check the connection of the capacitor cables
- Measure the resistance values and check the capacitor values
- Check whether it is working by connecting via the terminals S,R and C connection
- If it is working, start the machine and check the drum temperature.

The terminals S and R of the motor should be connected with capacitor.

Resistance measurement of main winding: Terminal C-R is measured.

Resistance measurement of aux winding: Terminal C-S is measured.

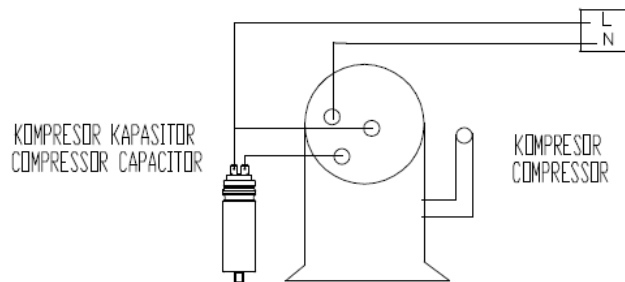

7.5.1. Compressor Measurements

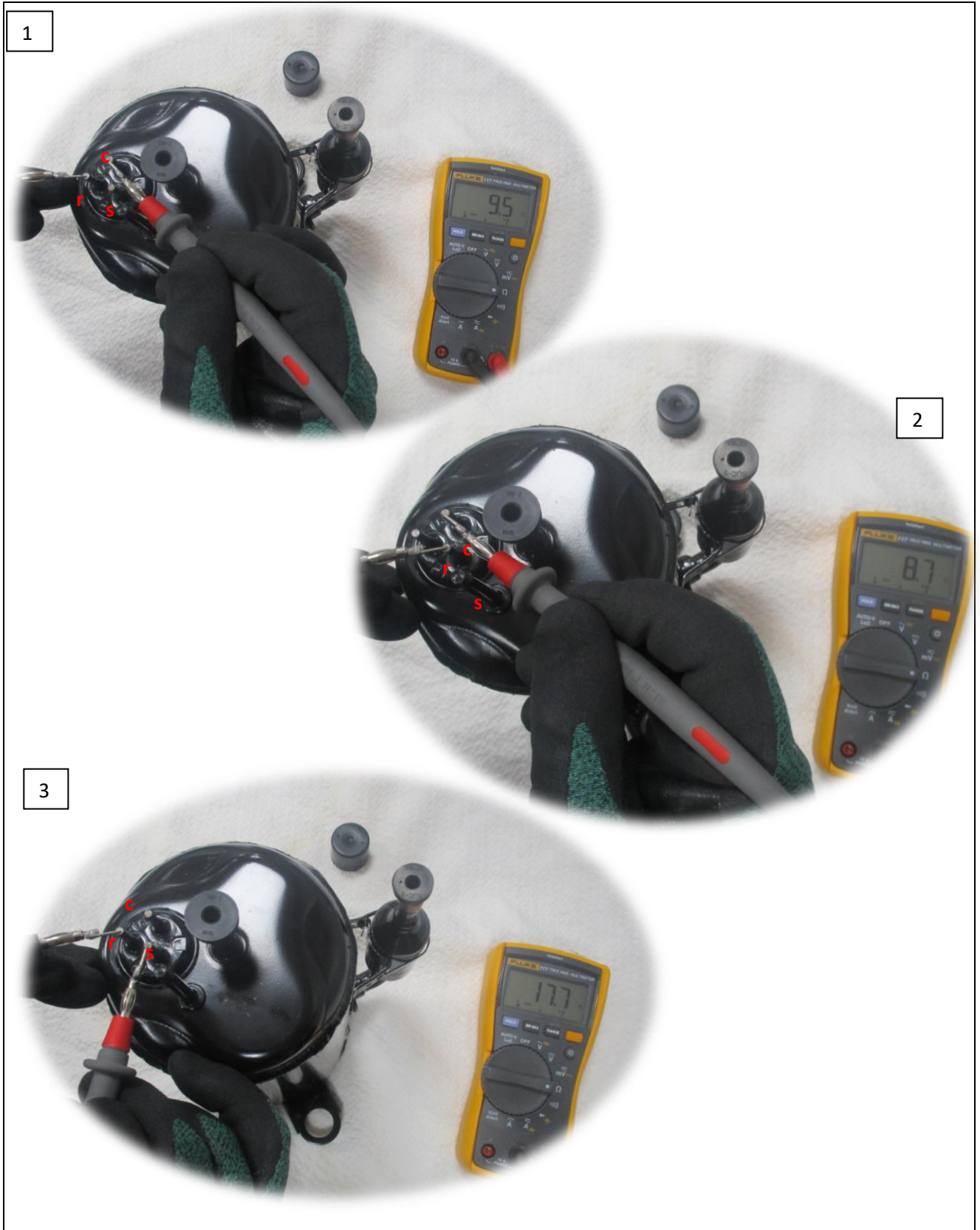

7.6. Door Latch

Door latch locks when the door is closed. It's designed to be opened from inside, in case of children are in the drum



Component Test

- When the door is closed, check whether there is electrical transmission from IDC connected to electronic card
- Check the connection of the component connector

7.6.1 Door Latch Measurements



7.7. Humidity Sensor

The Humidity Sensor measures the amount of dryness of the laundry in the drum.



Component Test

- Each humidity sensor plate is checked whether there is electrical transmission from IDC connected to electronic card.
- Check the connection of the component connector

7.7.1 Humidity Sensor Measurements



7.8. Cooling Fan

The dryer has an cooling fan with an asynchronous motor. In the photo on the right, the terminal on the compressor are shown to be measured by multiple counters. It is driven with triac via the electronic card (to give energy)



Technical Features

Type: single-phase AC fan

Power: 28 W

Main windings: 600±7%

Motor speed : 2600/3000 ±10%

Component Test

- Check whether the cooling fan cable is connected to the fan terminal.
- Measure the resistance values

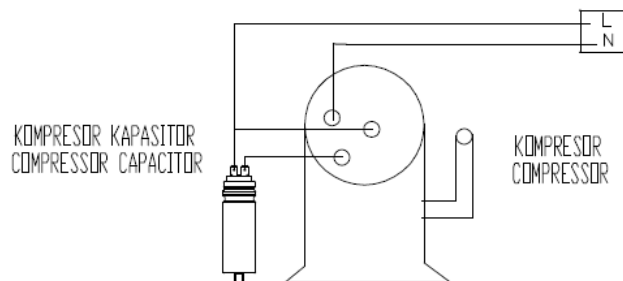

7.8.1. Cooling Fan Measurements

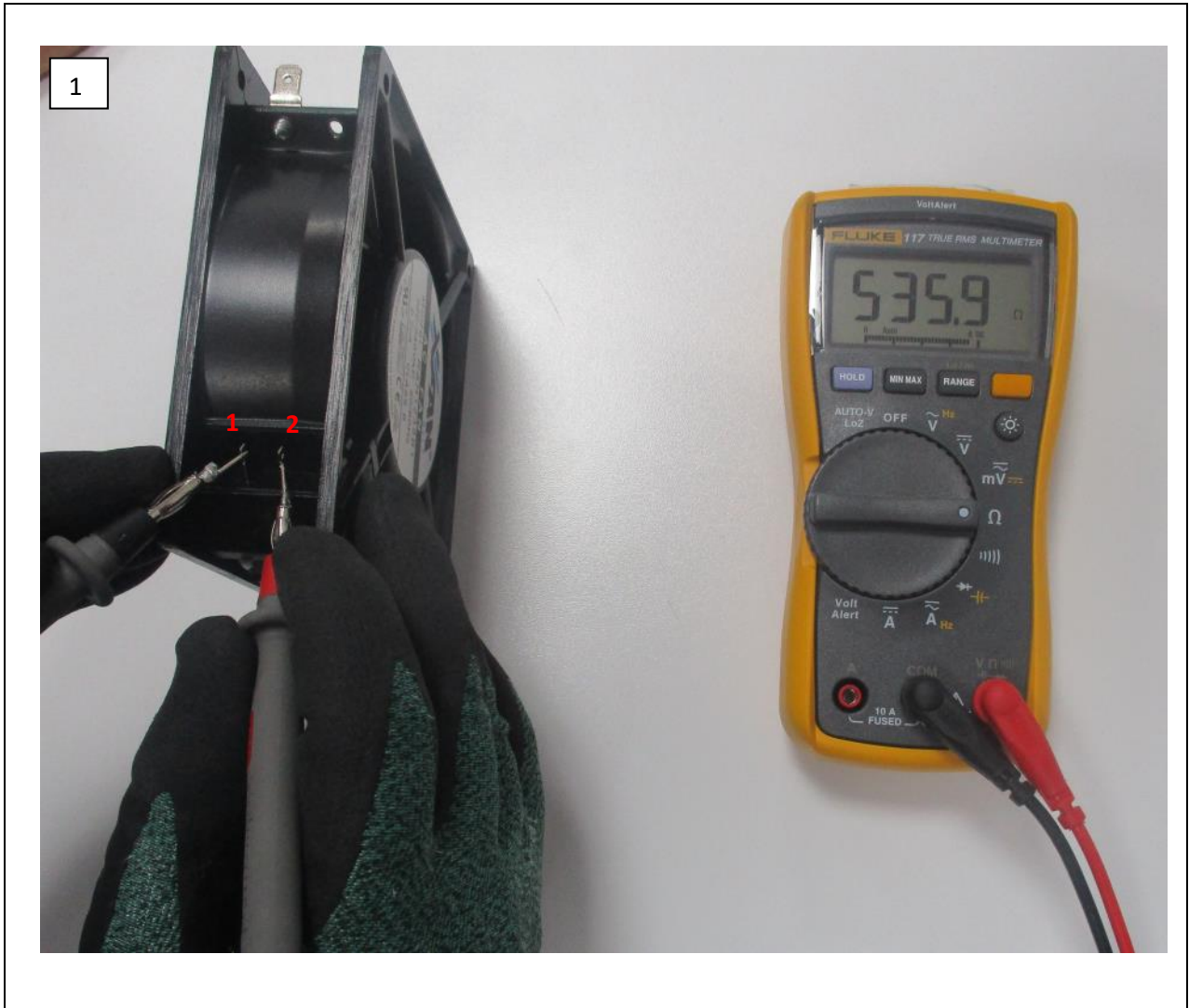

7.9. Drumlight

Drumlight lights inside of the drum



Component Test

Check whether there is electrical transmission from IDC connected to electronic card.

8. TROUBLESHOOTING

