



SERIES T2 TOUCH

MANUEL DE SERVICE

1. Specifications

1.1. Product Specifications

	42 lt	44 lt	49 lt	50 lt	54 lt	55 lt	60 lt	59 lt	61 lt	62 lt
Product Type	Front Loader									
Capacity	5 kg	6 kg	7 kg	8 kg			9 kg		10 kg	
Max Spin Speed (r/min)	800 - 1000 - 1200 - 1400									1200 -1400
Energy Efficiency	A++	A+++	A+++	A+++ (-10%)	A+++	A+++ (-20%)	A+++ (-40%)	A+++	A+++ (-20%)	A+++ -%10
Washing Efficiency	A									
Spinning Efficiency	800 rpm → D 1000 rpm → C 1200 rpm → B 1400 rpm → B								1200 rpm → B 1400 rpm → B	
Control Panel	LED display -									
Wash Programs	15 settings									
Dimensions	Height	84,5 cm	84,5 cm	84,5 cm	84,5 cm		84,5 cm	84,5 cm		84,5 cm
	Width	59,7 cm	59,7 cm	59,7 cm	59,7 cm		59,7 cm	59,7 cm		59,7 cm
	Depth	49,7 cm	49,7 cm	52,7 cm	55,7 cm		58,2 cm	58,2 cm		58,2 cm
Other Features	Child Lock									
	Delay Time									

1.2. Name Plate

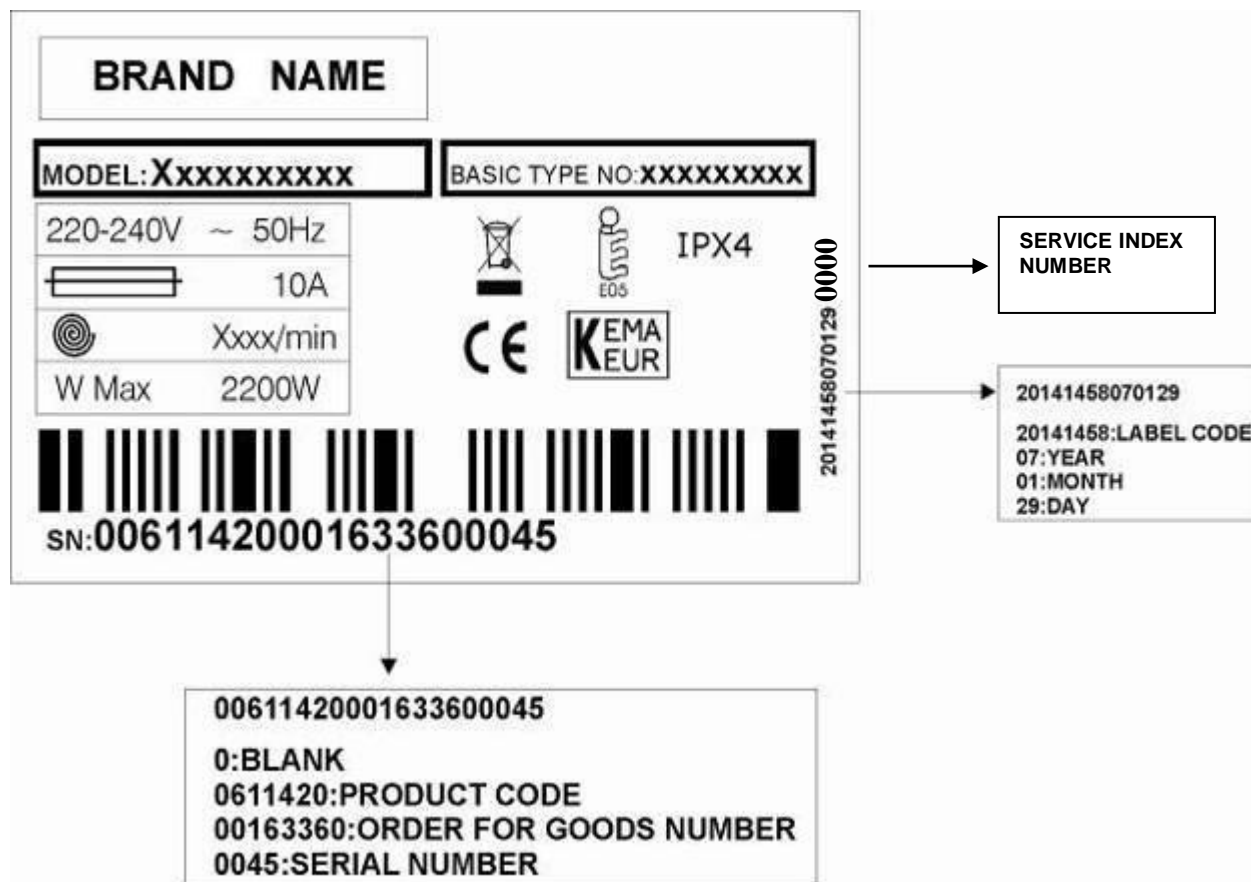

2. Installation Instructions

2.1. Moving and Installing

2.1.1. Removal of Transportation Screw

1. Transportation screws, which are located at the back side of the machine, must be removed before running the machine.
2. Loosen the screws by turning them anticlockwise with a suitable spanner.

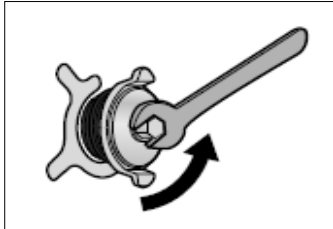

3. Pull out the screws and rubber washers.

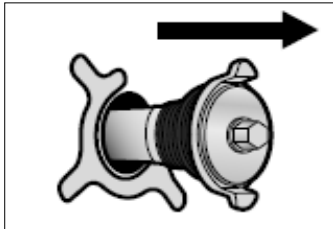

4. The holes where the transport screws have been removed should be covered with the plastic transport caps found in the accessories bag.

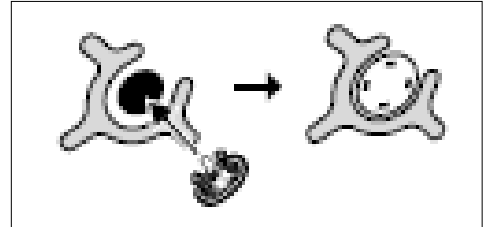

5. The transportation screws that have been removed from the machine must be re-used in any future transporting of the machine.

2.1.2. Foot Adjustment

1. Do not install machine on rugs or similar surfaces.
2. For machine to work silently and without any vibration, it should be installed on a flat, non-slippery firm surface. Any suspended floor must be suitably strengthened.
3. You can adjust the level of machine using its feet.
4. First, loosen the plastic adjustment nut away from the cabinet base.

5. Change the level by adjusting the feet upwards or downwards.
6. After level has been reached, tighten the plastic adjustment nut again by rotating it upwards against the base of the cabinet.
7. Never put cartons, wooden blocks or similar materials under the machine to balance irregularities of the floor.

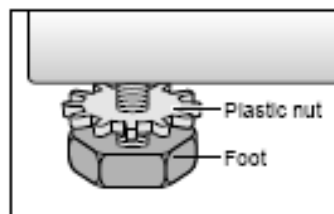

2.1.3. Electrical Connection

1. Washing machine requires a 50Hz supply of 220-240Volts.
2. A special earthed plug has been attached to the supply cord of washing machine. This plug must be fitted to an earthed socket. The fuse value fitted to this plug should be 13 amps. If you have any doubts about electrical supply, consult a qualified electrician.

**THIS APPLIANCE MUST BE EARTHED.
Insert the machine's plug to a grounded
socket which you can easily reach.**

2.1.4. Water Supply Connection

1. Washing machine is supplied with a single (cold) water inlet.
2. To prevent leakage from the connection joints, a rubber washer is included in the hose packing. Fit this washer at the end of water inlet hose on the tap side.
3. Connect the hose to the water inlet valve. Tighten the plastic connector by hand. Please call a qualified plumber if you are unsure about this.
4. Water pressure of 0,1-1 MPa from tap will enable machine to work more efficiently.(0,1 MPa pressure means water flow of more than 8 litres in 1 minute from a fully opened tap)

2.1.5. Drain Connection

1. Make sure that water inlet hoses are not folded, twisted, crushed or stretched.
2. The drain hose should be mounted at a minimum height of 60 cm, and a maximum height of 100 cm from the floor.

5. After connection is complete, check for leakage by turning on tap completely.
6. Make sure that water inlet hoses can not become folded, damaged, stretched or crushed when the washing machine is in its final position.
7. Mount the water inlet hose to a 3/4" threaded water tap.

3. The end of the drain hose can be connected directly to a drainage stand-pipe or alternatively to a specific connection point designed for that purpose on the waste outlet of a sink unit.
4. Do not extend the drain hose or guarantee will be invalidated.

2.2. Detergent Box Group

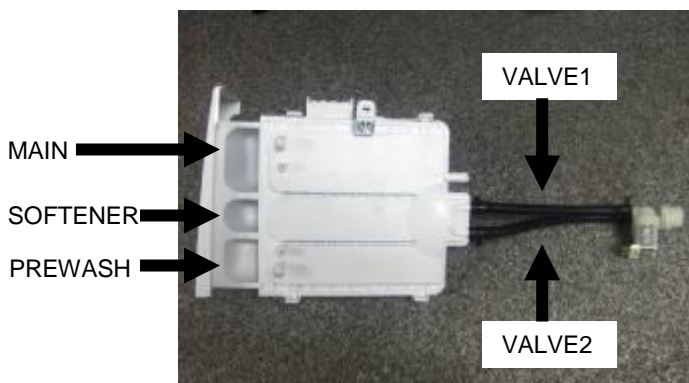

PREWASH = WATER ENTRY VALVE 1
MAIN = WATER ENTRY VALVE 2
SOFTENER = WATER ENTRY VALVE 1 + VALVE 2

3. Operating Instructions

3.1. LCD Screen, Function Buttons & Knobs

*T2 Touch Control Panel



*T2 Touch Jog Dial Control Panel



3.2. Program List

KNOB POSITION	PROGRAM
1	Cotton 60°C
2	Cotton 40°C
3	Cotton Prewash
4	Eco 20°C
5	Easy Care
6	Wool
7	Rinse
8	Allergy Safe
9	Spin
10	Delicate / Hand Wash
11	Sports Wear
12	Mix/Duvet*
13	Jeans
14	Daily 60'
15	Rapid 15'***
16	OFF

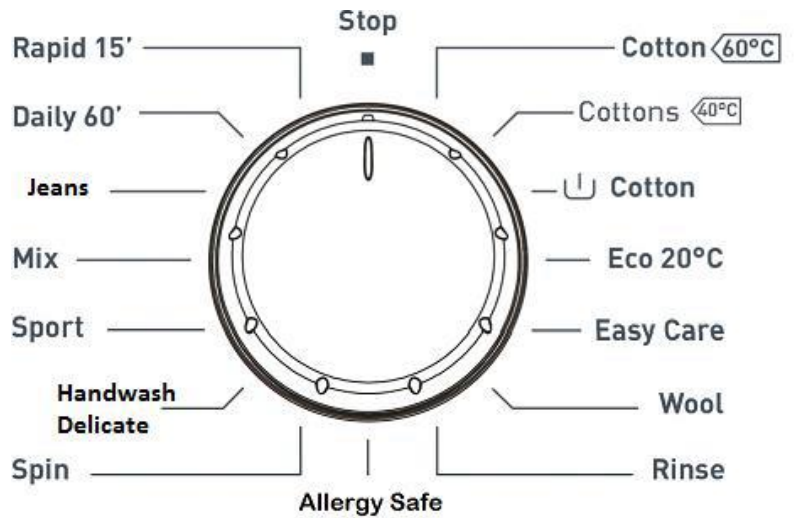

*Mix algorithm is available for 32, 40, 41+, 42, 44, 44+, 47, 49, 50, 54, 59lts. Duvet algorithm is available for 55, 60, 61, 62 lts.

**Rapid 15 is available for without twinjet model, Rapid 12 is available for with twinjet model.

3.3. Child Lock

Activation

1. Press the SW2 and SW3 buttons simultaneously for 3 sec.

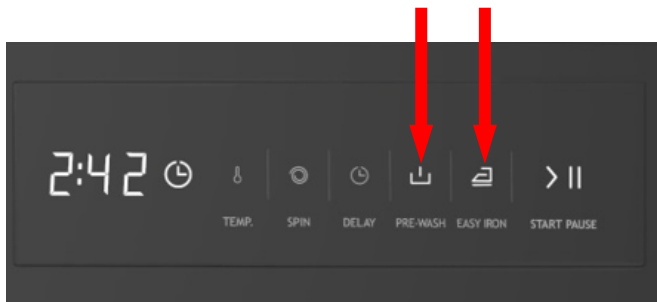

Deactivation

1. Press the SW2 and SW3 buttons simultaneously for 3 sec.

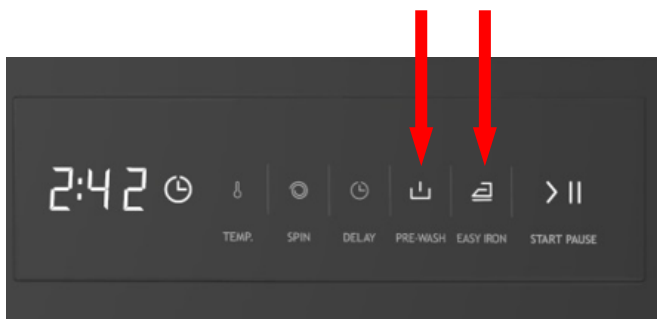

Child lock during selection:

Machine does not respond to any pressing of buttons or changing position of program knob. CL at 7 segment display will make fast blink for 2 sec to indicate child lock is activated.

Child lock during the program:

Machine does not respond to any pressing of buttons or changing position of program knob. "CL" is visualized on display for 2 sec to indicate child lock activation with tone D buzzer in models having buzzer option. After 2 sec "CL" indication is fixed off and remaining time is visualized on display.

In end condition

When cycle is finished child lock is automatically deactivated. It is not possible to activate child lock during End mode.

In Error Mode

Child lock will be automatically deactivated when error is detected

Child lock during delay mode:

Child lock can be activated / deactivated during delay mode. If child lock is active during delay mode, it will be kept locked until the end of washing (unless user deactivates by pressing SW2 and SW3 buttons simultaneously for 3 sec.)

4. Test Mode

4.1. Autotest

* This test is for quick checking of the product. You can not see the failure codes.

1. Set program knob at position 3. Push SW4 button. Keeping SW4 button pushed, turn program knob to position 2.

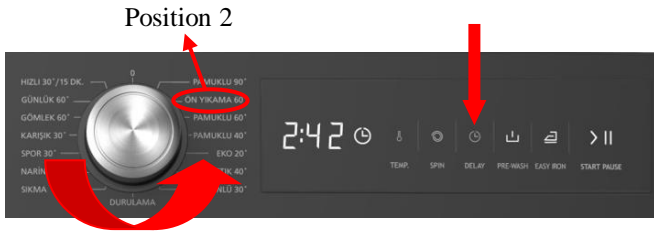

2. After 3 sec, door will be locked and machine enters autotest mode. Release SW4 button. "AU" will be visualized on LCD

The test steps are as below;

Step1: The pump is activated for 3 seconds and there is EPS check , the frequency value should be between the 46.04Hz and 43.40Hz. It checks the EPS and if it is OK it continues the autotest; if it is NOK then it should give E10 ERROR & cancels the autotest (goes to the selection mode). Also if any frequency can not be detected, then it means there is problem with connection or EPS, so it gives E10 which is EPS error and cancels the autotest.

Step2: The motor ramps to max spin for 15 seconds. While its speed rising up to the maximum speed the EV1 (prewash valve) is activated for 5 seconds and then the EV2 (wash valve) is activated for 5 seconds.

Step3: The motor reduces speed to stop (depends on the motor stop time) for 5 seconds. While it is slowing down it activates EV1 and EV2 valve, concurrently.

Step4: The motor turns to right.

Step5: The motor turns to left for 5 seconds.

Step6: The option 1 button is pushed

The EV1 and EV2 are activated concurrently until it reaches pressure sensor's first level frequency (Hz) for 5 seconds.

Step7: Software will detect NTC's resistance value and will check if the temperature is between $5^{\circ}\text{C} < T_{\text{detected}} < 40^{\circ}\text{C}$. If it is inside the range, heating step will be done. If temperature value is outside the range, then it means NTC is detecting the temperature in a wrong way and heating step will be skipped.

Step8: Autotest ends and "--" is visualized (T0). Autotest ends and "End" is visualized on LCD (In the rest of the models).

Flow chart of the autotest:

AUTOTEST													
Time in seconds (to be adjusted)	5	10	15	20	25	30	35	40	45	50	55	60	65
Entering autotest	█	█	█										
Changing power to 220 50Hz		█	█										
Main Voltage 50 Hz			█	█	█	█	█	█	█	█	█	█	█
Door Lock Powered (Depends on door lock)			█	█	█	█	█	█	█	█	█	█	█
Motor Ramp to max spin (max. is 15 sec.)				█	█	█	█	█	█	█	█	█	█
Time until motor is stopped (Depends on the motor stop time)								█	█	█			
Motor Preferred Run (Direction to Right)									█	█	█		
Motor Inverse Run (Direction to Left)										█	█	█	
EV1 (flowrate dependent of washer)					█	█	█		█	█			
EV2 (flowrate dependent of washer)							█	█	█				
EV1 + EV2 valves up to first level frequency (Depends on the water level) (If machine is a hot water one, take water from Hot Valve)											█	█	
NTC check												█	
Heather resistance													█
Pump					█	█							
EPS measurement					█	█							
End Visualization (On Display)													█

During test "AU" is visualized on display, at the end of the test "--" is visualized and door is unlocked. During test, pressing other buttons makes no change on display.

5. Service Mode

5.1. Service Autotest

End users can only see E1-E2-E3-E4. During service autotest, other failures can be seen.

1. To activate service autotest mode in touch models, set program knob at position 3, push SW3 button. Keeping SW3 button pushed, turn program knob to position 2.



2. After 3 sec, door will be locked and machine enters service autotest mode.

	Selector Position 1	Selector Position 2	Selector Position 3
	Result	Result	Result
	HEATER ON	PUMP ON	RAPID 15' PROGRAM
Comments :	When entering in service test, door will be locked.		TEST IS OVER Door will be unlocked, machine will go to END state.

The test steps are as below ;

Step 1 :

Selector position 1 will be "HEATER ON"
Before heating it should take water till first level frequency then start heating.
Heater will be on max. 8 minutes.If temperature doesn't increase 2°C in 8 minutes,machine will give NTC failure. (E05).
Or if the NTC connection is broken then it should give again E05 NTC failure.
At the end of heating, "SA" or "SAU" visualization should make slow blink to indicate that the step is over.
Note : If user changes the selector position, machine will do what is defined for the new selected position.

Step 2 :

Selector position 2 will be "PUMP ON"
Temperature will be measured, if it is higher than 50°C, it should take 80sec. cooling water and then make "Drain+ 5sec.)

At the end of pump activation, "SA" or "SAU" visualization should make slow blink to indicate that the step is over.

Step 3 :

Selector position 3 will be "RAPID 15' "
So machine will make exactly the same algorithm of Rapid 15'.
So, time for selector position 1 is 15 minutes.
At the end of Rapid 15' the door will be unlocked and machine will go to END mode.

5.2. Failure Codes

Error Indication	Error Number	Indication For User	Indication For Service
		Yes/No	Yes/No
Door is not locked	E01	Yes	Yes
Door is unlocked during programme	E01	Yes	Yes
Lack of water	E02	Yes	Yes
Pump failure	E03	Yes	Yes
Overflow	E04	Yes	Yes
NTC or Heater Failure	E05	No	Yes
Motor Failure - 1 (Tachometer open-short circuit or motor connector is disconnected)	E06	No	Yes
Configuration Failure	E07	No	Yes
Motor Triac Failure	E08	No	Yes
Voltage Error	E09	Yes	Yes
Electronic Pressure Sensor	E10	No	Yes
Dryer Card Communication Error	E11	No	Yes
3D Communication Error	E12	No	Yes
LCD Communication Error	E13	No	No
Dryer Resistance Failure	E14	No	Yes
Twinjet Failure	E15	No	No
High Temperature Error	E16	No	Yes
Flowmeter Failure	E17	No	Yes
Dryer NTC Failure	E18	No	Yes
BLDC Failure	E19	No	Yes
Pyrojet Failure	E20	No	Yes
Detergent Dosage Pump Failure	E21	No	Yes
Softener Dosage Pump Failure	E22	No	Yes
Communication Failure Between PCB and BLDC Card	E23	No	Yes
Wrong LCD Software	E50	No	Yes
Wrong BLDC Software	E51	No	Yes

**Some of the error codes can not be seen based on changing the product types*

6. Troubleshooting Guide

All repairs which must be done on the machine should be done by authorized agents only. When a repair is required for machine or you are unable to eliminate the failure with the help of the information given below:

- Unplug the machine.
- Close the water tap.

FAILURE	PROBABLE CAUSE	METHODS OF ELIMINATION
Machine does not operate.	It is unplugged.	Insert the plug into the socket.
	Fuse is defective.	Change fuse.
	Start / Pause button has not been pressed.	Press the start / pause button.
	The program knob is in 0 (off) status.	Bring the program knob on the desired status.
	The door is not shut properly.	Shut the door properly. You should hear the click.
	Child lock is active.	See page 9.

Machine does not receive water.	Water tap is closed.	Open water tap.
	The water inlet hose may be bent.	Check the water inlet hose.
	The water inlet hose is obstructed.	Clean the filters of water inlet hose.
	The water inlet filter is obstructed.	Clean the valve inlet filters.
	The door is not shut properly.	Shut the door properly. You should hear the click.
Machine is not draining water.	The drain hose is obstructed or bent.	Check the drain hose.
	The pump filter is obstructed.	Clean the pump filter.
	The clothes are not placed inside the machine in a well-balanced manner.	Spread the clothes inside the machine in an orderly and well-balanced manner.
Machine is vibrating.	The feet of machine are not adjusted.	Adjust the feet.
	Transportation screws are not removed.	Remove transportation screws.
	There is a small amount of clothes in the device.	It does not prevent operation of the machine.
	Excessive amount of clothes are filled in the machine or the clothes are not placed in a well-balanced manner.	Do not exceed the recommended quantity of clothes and spared clothes in the machine in a well-balanced manner.

FAILURE	PROBABLE CAUSE	METHODS OF ELIMINATION
Excessive foam in the detergent drawer	Too much detergent has been used.	Press the start/pause button. In order to stop the foam, dilute one table-spoon of softener in half liter of water and pour it in the detergent drawer. Press the start/pause button after 5-10 minutes. Arrange the amount of the detergent properly in the next washing process.
	Wrong detergent has been used.	Use only the detergents produced for full automatic machines.
The washing result is bad.	Laundry too dirty for the program you have selected.	Select a suitable program.
	The amount of detergent used is not sufficient.	Use more detergent according to the detergent.
The washing result is not good.	Clothes exceeding the maximum capacity has been filled in machine.	Put the clothes in machine in a manner not to exceed its maximum capacity.
	Water may be hard.	Use the amount of detergent according to the declaration of the detergent producer.
	Distribution of the clothes in machine is not well-balanced.	Spread the clothes inside the machine in an orderly and well-balanced manner.
The water is seen in the drum during washing.	No failure. The water is at the lower part of the drum.	
There are residues of detergent on the clothes.	The pieces of some detergents which do not dissolve in water may stick to clothes as white stains.	By calibrating machine for "Rinsing" program, make an additional rinsing or eliminate the stains After drying with the help of a brush.
There are grey stains on the clothes.	These stains may be caused by oil, cream or ointment.	In the next washing operation, use the maximum detergent amount declared by the detergent producer.
The spinning process is not done or starts with delay.	No failure. The unbalanced load control works in that way.	The unbalanced load control system will try to distribute clothes in a homogenous manner. After clothes are distributed, passage to spinning process will be realized. In the next washing process, place clothes into the machine in a well-balanced manner.

7. Disassembly and Assembly Instructions

7.1. Top Plate

1. Remove two screws that fix the top-plate at the back.



2. Pull the door up.



2. Push the top-plate back and pull it up.



3. Remove screws that fix the door group.



7.2. Door

1. Remove two screws that fix the door. (by using the T25)



4. Put the door outside plastic with helping screwdriver as it is shown in the picture.

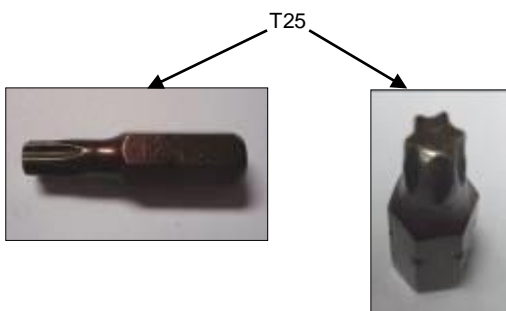

5. Remove the door inside plastic as it is shown in the picture.



8. Remove the door handle pin as it is shown in the picture.



6. Remove six screws that fix the door hinge as it is shown in the picture.



7. Remove the door handle as it is shown in the picture.



7.3. Tub Bellows Seal

1. First remove the spring wire fixing the tub bellows seal by using the small size screw driver. Pull the tub bellows seal as it is shown in the picture.



2. Remove the tub bellows seal-body fixing spring.



7.5. Control Panel

1. Remove the screw which fix the control panel to the front panel.



7.4. Detergent Drawer

1. Remove the detergent drawer and pull it up carefully



2. Remove three screws fixing the control panel.



3. Pull the control panel up.



4. Release the cable group as shown in the picture.



5. Remove the cable group as it is shown in the picture.

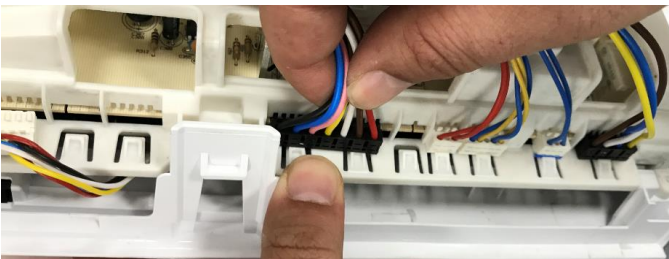

6. Remove electronic card cover as it is shown in the picture by using small screw driver.

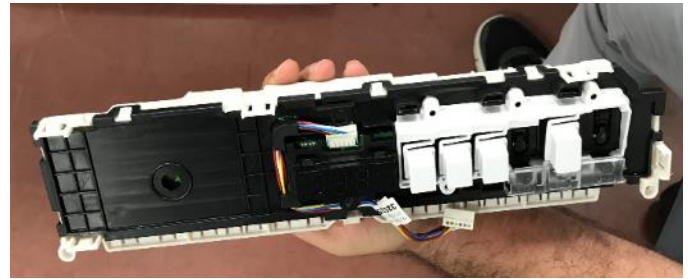

7. Remove electronic card as it is shown in the picture.

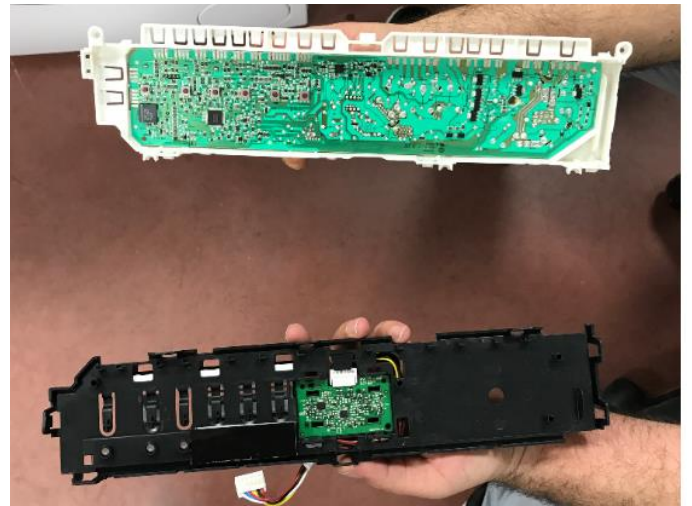
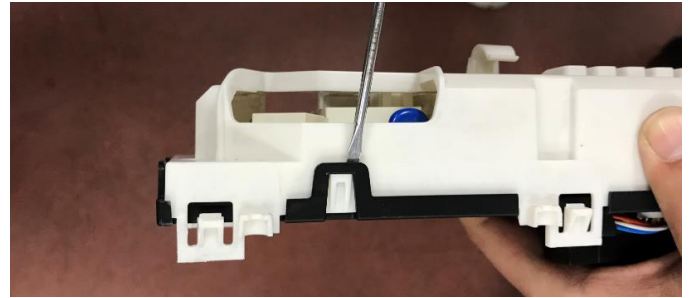

8. Remove the cable from display card, remove the display card and digit part as it is shown in the picture by using small screw driver.



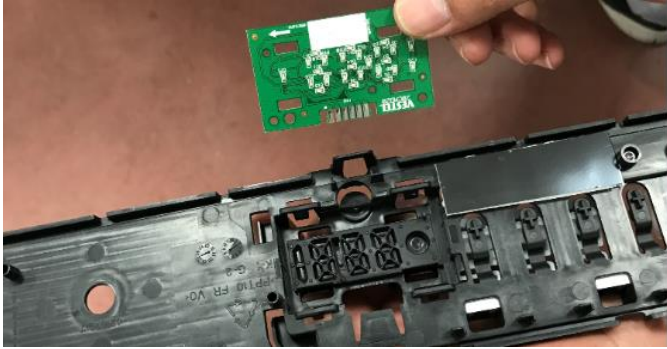
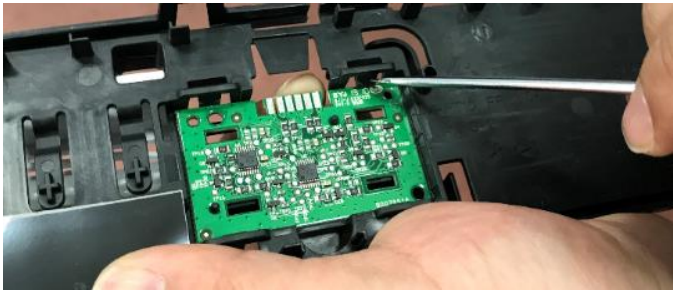

9. Remove selection button as it is shown in the Picture.

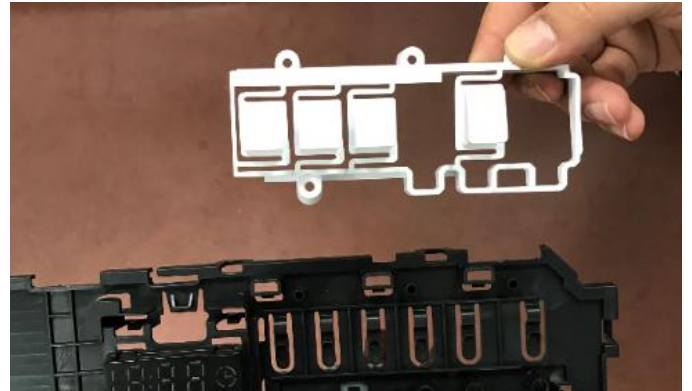
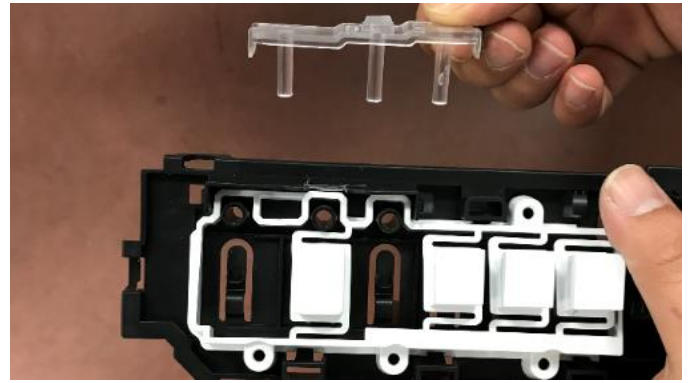
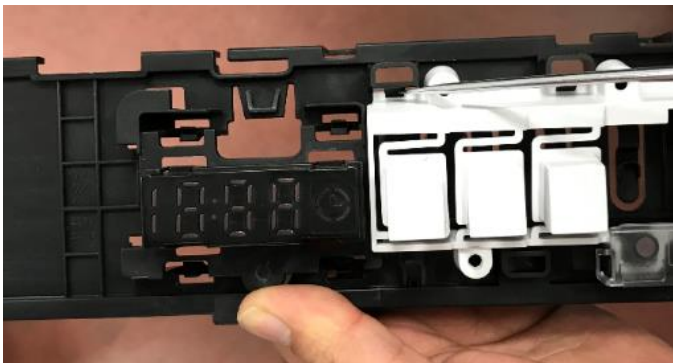

7.6. Front Panel

1. Remove the pump cover as it is shown in the picture.



2. Remove two screws fixing bottom the front panel.

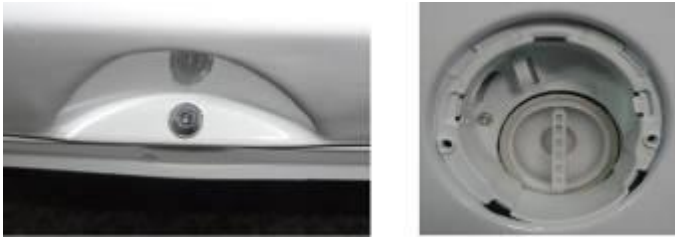
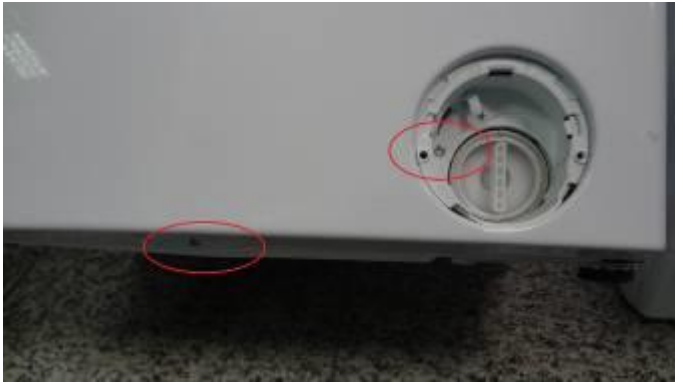

3. Remove two screws fixing upper the front panel.



4. Remove two screws fixing door lock it is shown in the picture.



5. Remove two screws fixing the body group at the front as it is shown in the picture.

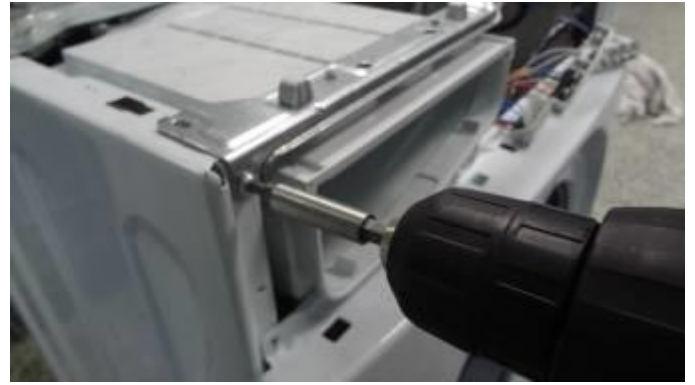

6. Lift upper support bracket up slightly it is shown in the picture.



7. Remove the pump cover housing as it is shown in the picture.





8. Remove the front panel as it is shown in the picture.



7.7. Detergent Drawer Housing

1. Remove detergent drawer group clips from the upper support bracket as it is shown in the picture.



2. Remove the tub seal clamp by using the pliers, which is attached to the detergent drawer housing.



3. Remove the four connectors that is connected to the feed valve as it is shown in the picture.



4. Turn the feed valve counter clockwise slightly to remove.



5. Remove the detergent drawer screw.



6. Remove the detergent drawer housing assembly.



7.8. Power Cable Group and Parazit Filter

1. Remove the five connectors that is connected to the parasite filter.



2. Remove two screws fixing the parasite filter.



3. Pull the power cable group up as it is shown in the picture.



4. Remove parasite filter fixing body group as it is shown in the picture.



7.9. Electronic Pressure Switch (EPS)

1. Remove the connector that is connected to the EPS.



2. Pull the EPS upward to remove as it is shown in the picture.



3. Remove the eps hose handcuffs and eps hose as it is shown in the picture.



2. Remove pipe clip fixing the tub outlet hose.



3. Remove the connector that is connected to the pump motor.



4. Remove four screws fixing the pump motor.



7.10. Door Lock

1. Remove the connector that is connected to the door lock.

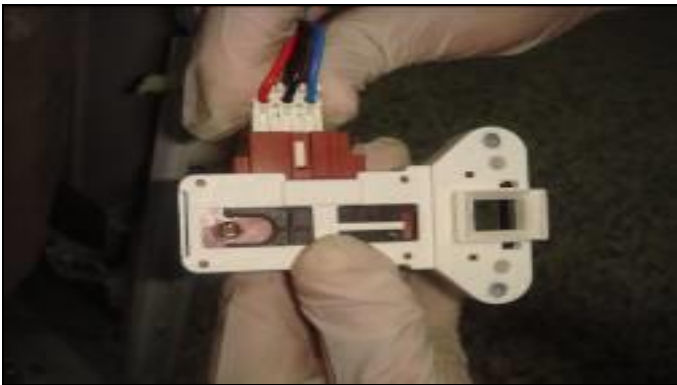

7.11. Pump Motor

1. Remove pipe clip that fixes the drain hose.



7.12. Front Counterweight

1. Remove four screws fixing the front counterweight on the front. (Box wrench size 13 mm)



2. Pull the counterweight back



7.13. Heater

1. Remove the four connectors that is connected to the heater.



2. Remove one nut fixing the heater slightly (box wrench size 8 mm)



3. Hold the heater and pull it out.



7.14. Twinjet System*

**(If product has TJ System)*

1. Remove the clamps with the help of screwdriver, pull the hose upwards and remove it from the nozzle.



2. Remove the screw that fixes the circulation pump to the body.



3. Lay down the machine backward, press to clips.



4. Remove the circulation pump.



5. Remove the pump socket.



6. The clamps on the pump are slid with the help of pliers and the hoses are pulled out.



7.15. Tub Bellows Seal

1. Remove the tub gasket clip by using small screwdriver.



2. Hold the tub bellows seal and gasket-body fixing spring together, and pull them up.



7.16. Transport Screw

1. Remove four transport screws (box wrench size 10 mm)



2. Hold the transport screw and pull it out.



7.17. Upper Counterweight

1. Remove two screws fixing the upper counterweight by using box wrench size 13 mm.



2. Remove the upper counterweight



7.18. Washing Group

1. Remove the connector that is connected to the motor.



2. Cut the five lead wire holders as shown the pictures.

a)



b)



c)



d)



3. Remove the four screws fixing the spring hanger sheet iron.



4. Remove the washing group as it is shown in the picture.



7.19. Shock Absorber PIN

1. Remove two pins fixing the shock absorber as shown in the picture.



7.20. Belt

1. Remove the belt as it is shown the picture.



7.22. Motor

1. Remove the four screws fastening the motor under the tub by using T40



7.21. Driven Pulley

1. Remove the screw fixing driven pulley it is shown the picture (By using T40).



2. Pull the motor up for disassembly.



2. Remove the driven pulley it is shown the picture.



7.23. Tub Entrance with Bellow Hose

1. Remove the tub entrance with bellow hose.



7.24. Pressure Switch Hose Group

1. Remove screw fixing the pressure switch water reservoir.



2. Remove the tub exit with bellow hose with ball by using box wrench size 10 mm.



7.25. Drum

1. Remove the drum.

7.24. Tub

1. Remove twenty four screws fixing tub using box wrench size 8 mm.



7.26 BLDC Card (For BLDC Models)

1



Remove the bottom plate by tilting the machine

2



This is the only way to remove the card without removing the washer group

3

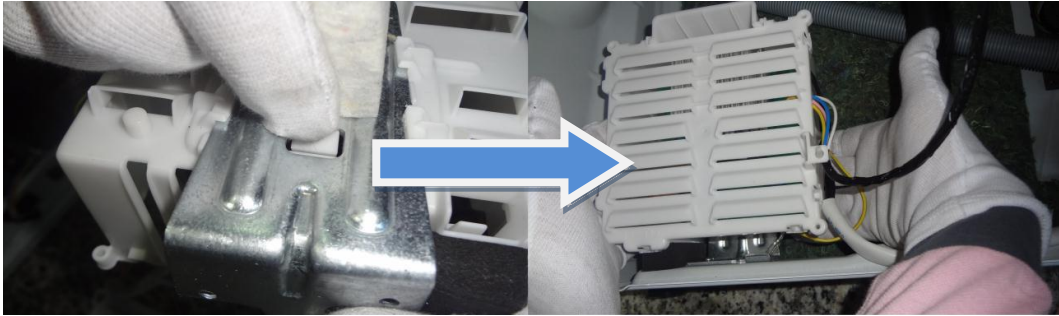

Remove the card by pressing the clip that placed behind (it could be seen on the first image) of the card and pushing the card.

4



Remove the connection

5



Remove the cable group that belongs to card

6



Remove the card box that belongs to the pyrojet unit, by pressing the clips with screw driver.

7



Remove the card by pressing the clips around with screw driver.

8

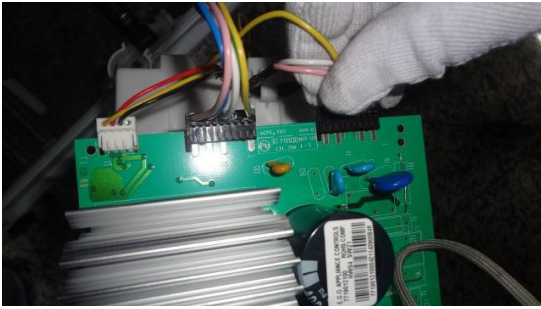

Remove the connections.

9



Remove the card completely

10



Remove the BLDC motor card fixing screws.

11



Remove the ground connection and make sure this connection is plugged during the assembly.

8. Component Specifications

8.1. Drain Pump

Drain pump is both a mechanical and electrical component which is used to drain water inside the washing machine. It has an synchronous motor inside. For better performance maintenance, pump filter should be cleaned regularly.



8.1.1. Technical Features

Nominal voltage	220 - 240 V
Nominal current	0.28 A ($\pm 10\%$)
Nominal power	37 W
Frequency	50 Hz
Resistor (coil)	130 Ω ($\pm 5\%$)
Water flow:	17 L/min(to 1 m height)
Thermal protector	YES

8.1.2. Checking of Component

Check the resistance value on the component with multimeter as shown in belows figures.

Resistance value should be between 125- 140 Ω



Checking the component

8.2. Resistance

Heating element (Resistance) is a component which is designed to regulate temperature of water inside the drum. It has three connections: Phase, notral and ground connections.



8.2.1. Technical Features

Kind of heating	Tubular heating element with NTC – sensor
Nominal voltage	230 V
Nominal power	2000 W ($\pm 5\%$)
Resistance	24,8 $\pm 5\%$ Ω
Thermal fuse	2 – sided

8.2.2. Checking of Component

Check the resistance value on the component with multimeter as shown in below pictures.



Checking the component

8.3. NTC

Component which sends signals to PCB about the water temperature inside the tub.

The Resistance (Ohm) value of the NTC decreases as the temperature increases.



8.3.1. Technical Features

Tem (°C)	R min (kΩ)	R max (kΩ)
-10	54,9	62,6
-5	43,0	48,6
0	33,9	38,1
5	27,0	30,1
10	21,6	23,9
15	17,4	19,1
20	14,1	15,4
25	11,5	12,5
30	9,4	10,2
35	7,8	8,3
40	6,4	6,9
45	5,4	5,7
50	4,5	4,7
55	3,8	3,9
60	3,2	3,3
65	2,7	2,8
70	2,3	2,4
75	1,9	2,0
80	1,7	1,8
85	1,4	1,5
90	1,2	1,3
95	1,1	1,1
100	0,9	1,0

NTC Tempure – Resistance Values

8.3.2. Checking of Component

Check the resistance value on the component with multimeter as shown in below pictures.



Checking the component

8.4. Valve

Valve is an electrical and mechanical component which is designed to take water from the network system into the washine machine. It is operated by PCB card.

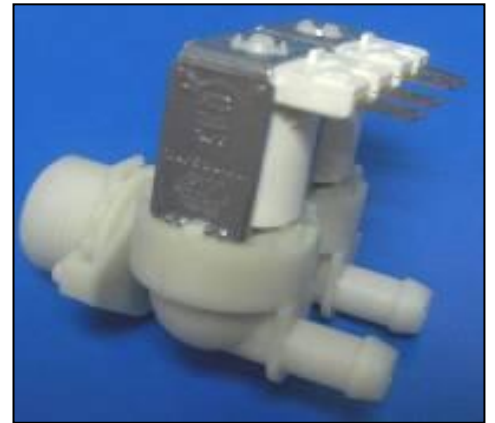

8.4.1. Technical Features

Nominal voltage	220 – 240 V
Nominal power	8 VA
Frequency	50-60 Hz
Rated flow:	7 lt/min ($\pm 15\%$)
Operating water pressure	0.0,3 – 1 Mpa

8.4.2. Checking of Component

Check the resistance value on the component with multimeter as shown in below pictures.

Valve water flow rate should be between 6 lt/min - 8 lt/min.

Each valve bobbin resistance values should be between 3,3 - 4.2 kohm .



Checking the component

8.5. Electronic Pressure Switch (EPS)

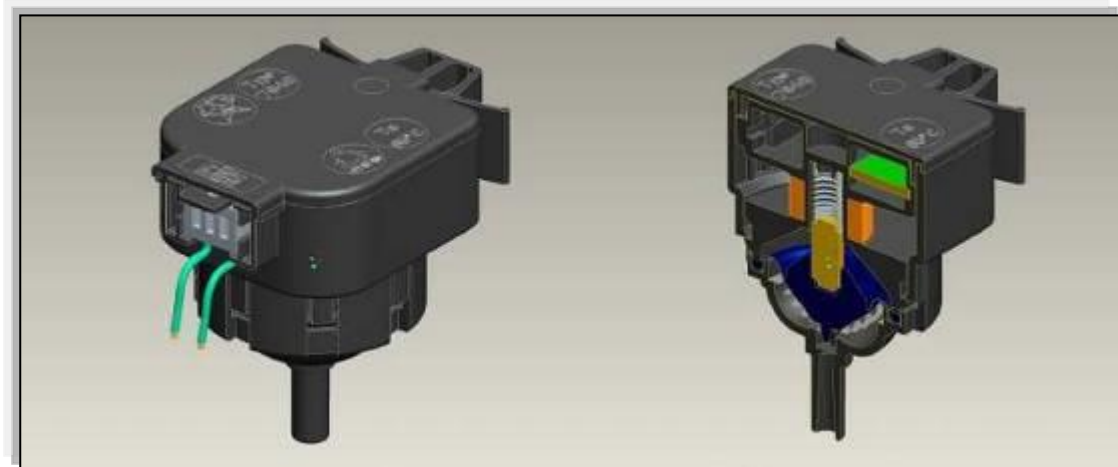

8.5.1. Technical Features

Electromagnetic field occurs as a result of the vibration of the membrane which is under pressure in the coil. The nucleus part is moved up and down by the electromagnetic field. The water level is regulated by the frequency which is controlled by the PCB and changes according to the movement of the nucleus part.

8.5.2. Checking of Component

1. Make sure there are no laundry in washing machine, tap is connected and opened, power cord is plugged. Put no detergent in drawer.
2. Bring program knob to position 1 (Cotton 90°C program)
3. Press start button.
4. Wait for water intake step to finish. You can recognise it by listening the water sound or slightly opening and observing detergent drawer.
5. As soon as water intake is over turn program knob to position 0 (Off position)
6. Check water level from door glass. The water level should be just below door glass as seen in the picture below: (There is a %10 tolerance with this level)



8.6. Motor (Could be Brushed or Brushless based on Model)

There are 2 types of motor, one of them is brushed motor and the other one is brushless motor. Motor type can be change depend on product.

8.6.1. Brushed Motor

The washing machine has an asynchronous motor. It is controlled by the PCB.

It is essential to check the motor for correct diagnosis and quick servicing. In the below picture, socket points on the motor is shown to measure with multimeter.

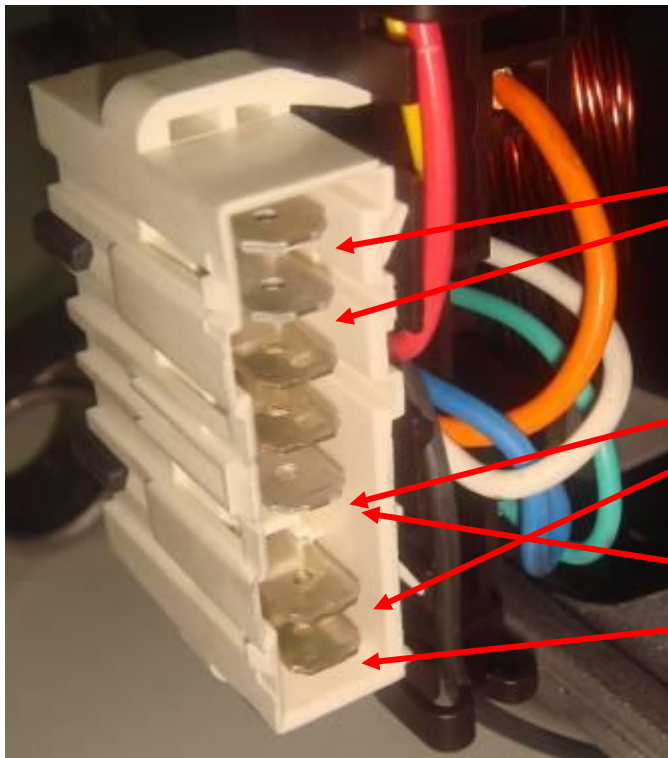
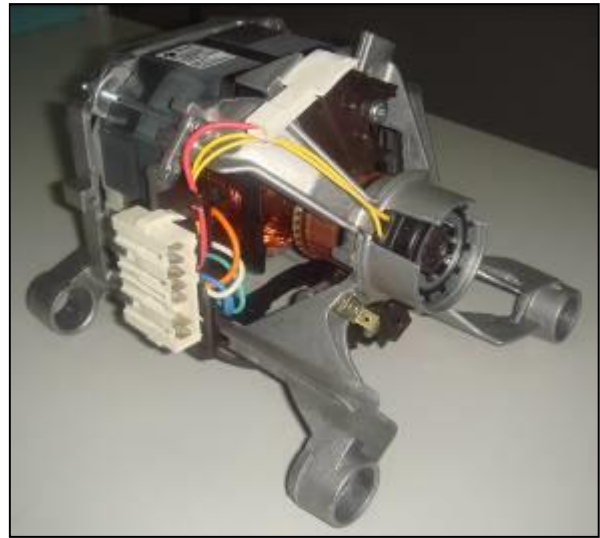

Tacho
Socket
Terminal

Stator Full Field
Coil Socket
Terminal

Stator Half Field
Coil Socket
Terminal

Motor Socket Terminals

Tacho and stator (full field-half field) ohm resistance values for the motor types are listed in the below table.

MOTOR CODE	SUPPLIER	STATOR	AUXILIARY WINDING	TAKO
		Resistance	Resistance	Resistance
32016268	WELLING	2,00 ± %7 Ω	NA	66,6± %7 Ω
32030654	G&J	1,86-2,14 Ω	NA	60,69-69,83 Ω
32016267	WELLING	1,45 ± %7 Ω	NA	66,6± %7 Ω
32031898	G&J	2,10-2,42 Ω	NA	60,69-69,83 Ω
32030127	WELLING	1,68 ± %7 Ω	NA	66,6± %7 Ω
32028497	NIDEC	1,63 ± %7 Ω	0,82 ± %7 Ω	184 ± %7 Ω
32028498	WELLING	1,377 ± %7 Ω	0,785 ± %7 Ω	66,6 ± %7 Ω
32030432	WELLING	1,68 ± %7 Ω	1,55 ± %7 Ω	66,6± %7 Ω
32017283	WELLING	1,93 ± %7 Ω (AL)	NA	66,6± %7 Ω
32013652	HAIER	2,65 ± %7 Ω	NA	68,8 ± %7 Ω
32032079	TONLON	2,28 ± %7 Ω	NA	70,2± %7 Ω
32030653	G&J	2,28-2,63 Ω	NA	60,69 - 69,83 Ω
32037679	KENING	2,10 ± %7 Ω	NA	63,6± %7 Ω
32031043	G&J	2,03-2,34 Ω	NA	60,69 - 69,83Ω
32027577	WELLING	2.39±7%Ω	NA	66,6±7%Ω
32027576	HAIER	2.36±7%	NA	68,8± %7 Ω
32019342	WELLING	2,00 ± %7 Ω	NA	66,6± %7 Ω
32034697	G&J	1,82 ± %7 Ω	NA	65,26± %7 Ω
32032630	HAIER	1,27 ± %7 Ω	NA	68,8± %7 Ω
32019343	WELLING	1,67 ± %7 Ω	NA	66,6± %7 Ω
32034698	G&J	1,82 ± %7 Ω	NA	65,26± %7 Ω
32031529	HAIER	1,27 ± %7 Ω	NA	68,8± %7 Ω
32004905	NIDEC	2,70 ± %7 Ω	1,04 ± %7 Ω	184 ± %7 Ω
32027578	WELLING	1,21 ± %7 Ω	NA	66.6 ± %7 Ω
32025348	NIDEC	1,72 ± %7 Ω	0,70 ± %7 Ω	184 ± %7 Ω
32028496	ANAIMEP	1,36 ± %7 Ω	0,70 ± %7 Ω	180 ± %7 Ω
32030431	NIDEC	1,50 ± %7 Ω	0,75 ± %7 Ω	184 ± %7 Ω
32033330	WELLING	1,38 ± %7 Ω	0,761 ± %7 Ω	66,6± %7 Ω
32030003	NIDEC	2,25 ± %7 Ω	1,03 ± %7 Ω	184 ± %7 Ω
32028925	NIDEC	2,70 ± %7 Ω	1,14 ± %7 Ω	184 ± %7 Ω
32033617	WELLING	2,04 ± %7 Ω	0,99± %7 Ω	66,6 ± %7 Ω

Resistance values for the motor types

8.6.2 Brushless Motor

The washing machine has an asynchronous motor. It is controlled by the PCB. It is essential to check the motor for correct diagnosis and quick servicing. In the below picture, socket points on the motor is shown to measure with multi meter.



UNIVERSAL MOTOR

BLDC MOTOR

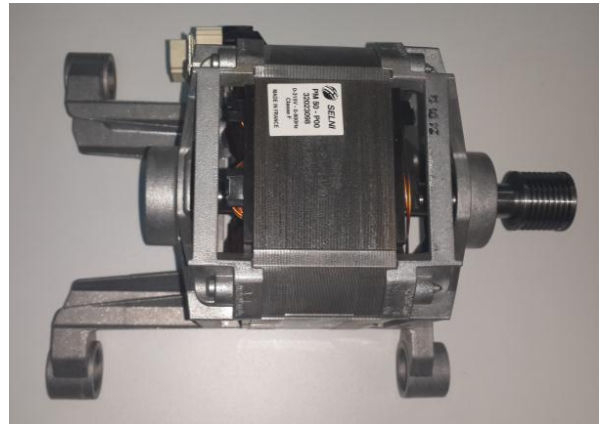

Motor

3 phase brushless DC Motor.

Ferrite Magnet

Stator resistance (phase- Neutral) $2,38 \pm 7\% \Omega$

Motor socket terminals

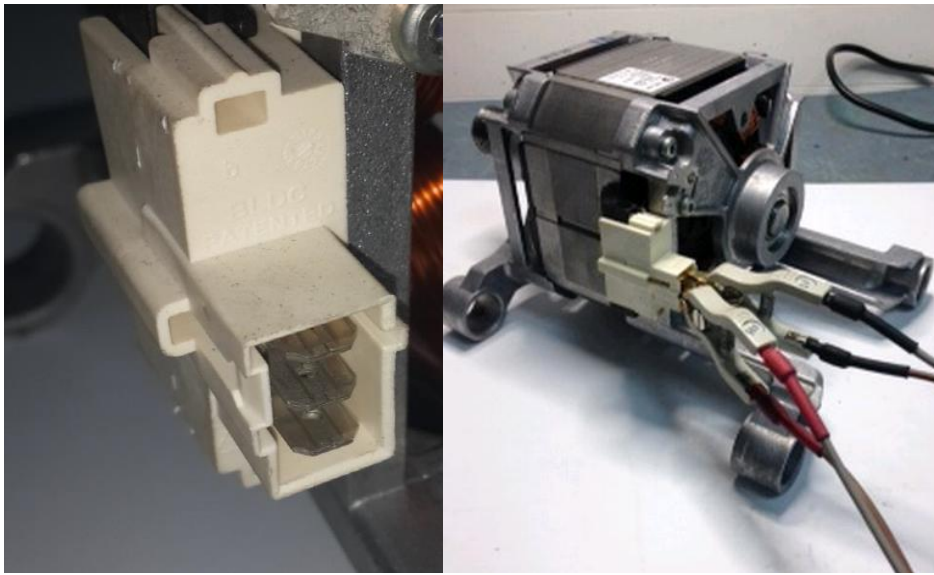

Measurement of resistance and inductance are done between the terminals.

8.7. Door Lock

Door lock is activated at the beginning of the program in order to prevent the door from opening. It can be unlocked approximately after 2 minutes of the program end. This time delay is caused by the PTC which is assembled in the door lock.



8.7.1. Technical Features

Lock Time (20 °C)	2" – 6"
Unlock Time (20 °C)	35" – 75"
Nominal voltage	220 V
Nominal current	16 (4) A

8.7.2. Checking of Component

Check the resistance value on the component with multi-meter as shown in below figures.

Resistance value on the PTC should be $1000 \Omega \pm 50\%$ at 25 °C. That resistance value can be measured from terminal 3-4 (See wiring diagram page 51 below).



9. Wiring Diagram

TUB BELLOW SEAL REPAIR INSTRUCTION

1. Disconnection



1.1 Remove the plug



1.2 Turn off the tap and disconnect the hose from the valve



1.3 Disconnect the drain hose

2. Necessary Tools



A. Pliers

B. Flat head thin screwdriver

C. Cordless screwdriver or classic screwdriver with torx bits (T20)

3. Disassembly Instructions

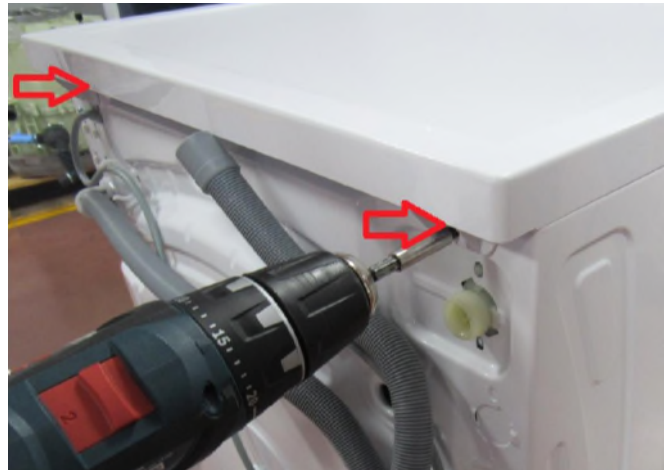

3.1 Remove two screws that fix the top-plate at the back.



3.2 Push the top-plate back and pull it up.

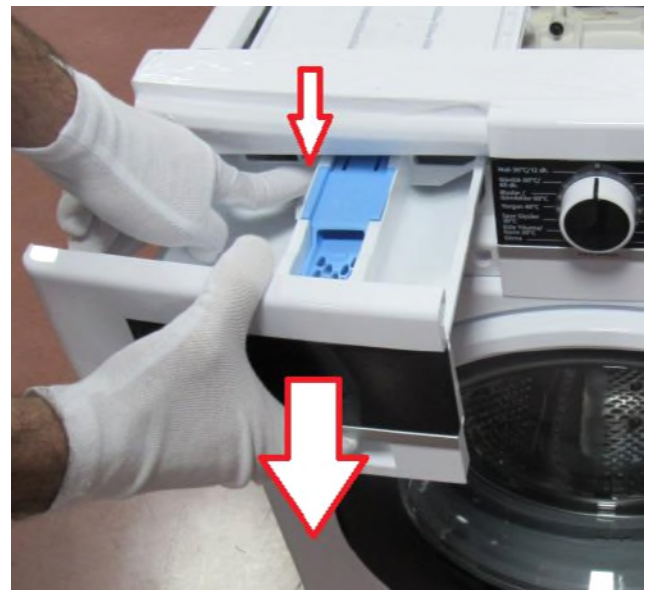

3.3 While pressing siphon cover keep pulling drawer to remove it.

TUB BELLOW SEAL REPAIR INSTRUCTION



3.4 Remove the screw which fixes the control panel to the front panel.

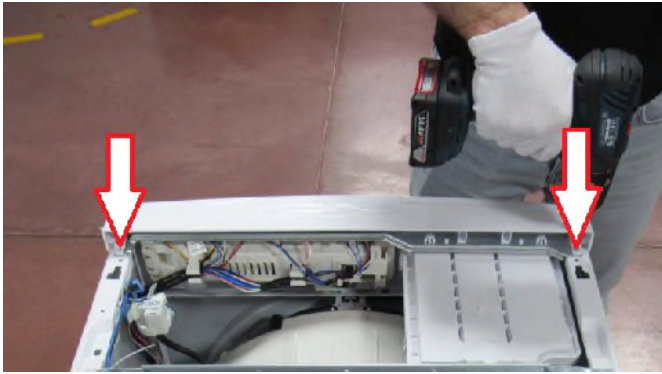

3.5 Remove two screws fixing control panel.



3.6 Remove the screw on support bracket and two screws fixing front panel to body



3.7 Remove the screw fixing twinjet elbow.



3.8 Remove the screws fixing the door lock.

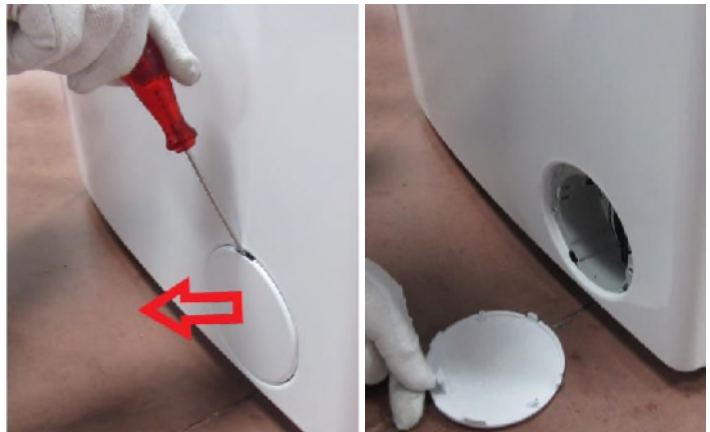

3.9 Remove the screw and plastic part located under the pump cover

TUB BELLOW SEAL REPAIR INSTRUCTION



3.10 Remove the screw fixing the front panel at the bottom.

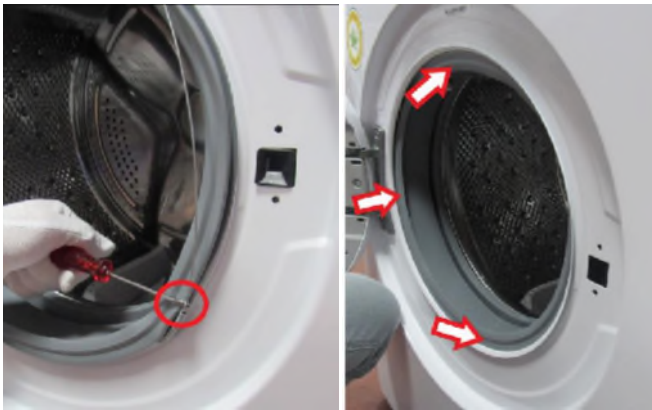

3.11 Remove the wire by using small screwdriver and push the seal to the inside



3.12 Pull up and remove the front panel.

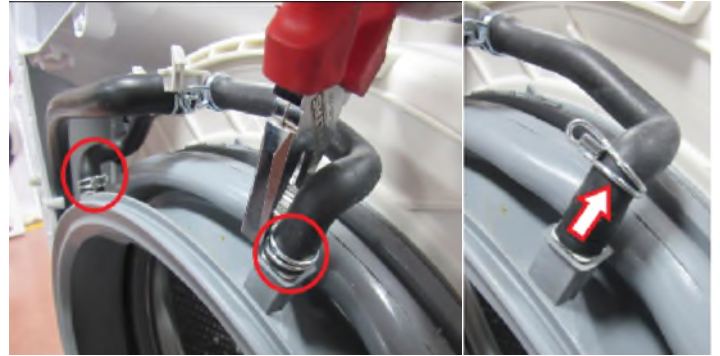

3.13 Remove twinjet hoses from tub bellow seal pulling them up.



3.14 Remove the tub gasket clip by using small screwdriver.



3.15 Hold the tub bellows seal and gasket-body fixing spring together, and pull them out.

TUB BELLOW SEAL REPAIR INSTRUCTION

4. Assembly Instructions



4.1 Guides must be matched

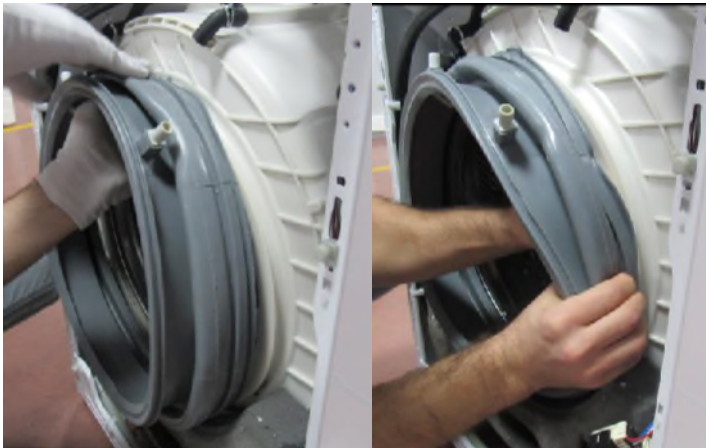

4.2 Fit the tub bellow seal to the front tub

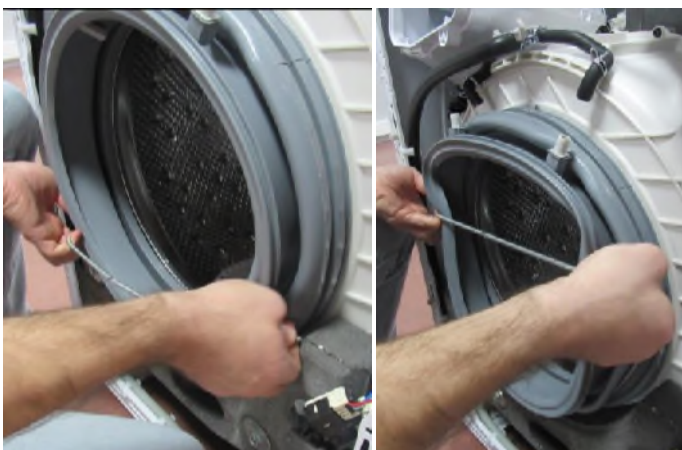

4.3 Pull the tub gasket clip to the up by hand and fit it

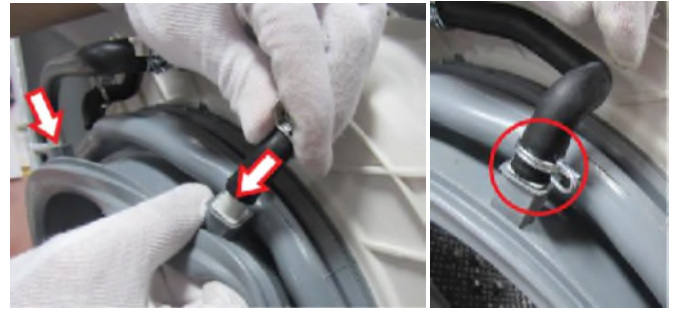

4.4 Assemble the twinjet nozes and tighten the clips

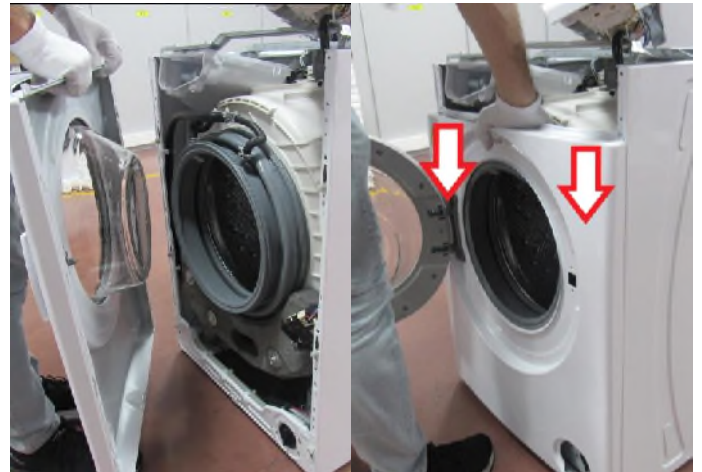

4.5 Put the front panel to the cabinet and push down to set it



4.6 Tighten the door lock screw

TUB BELLOW SEAL REPAIR INSTRUCTION



4.7 Pull the tub bellow seal to the outside and assemble the wire by using small screwdriver



4.8 Tighten the screw fixing the front panel at the bottom

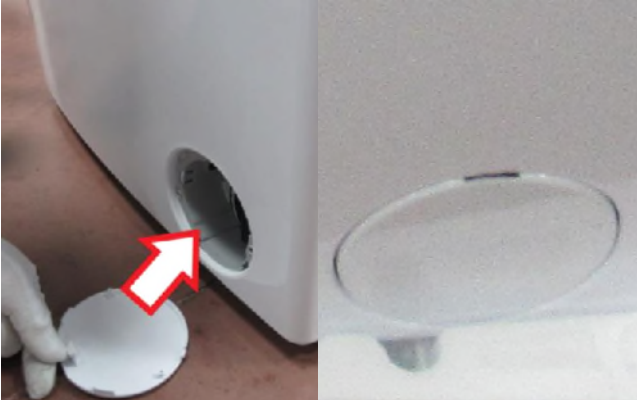
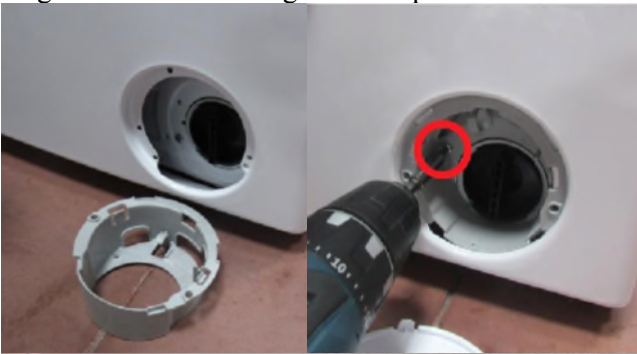

4.9 Fit the screw and plastic part located under the pump cover

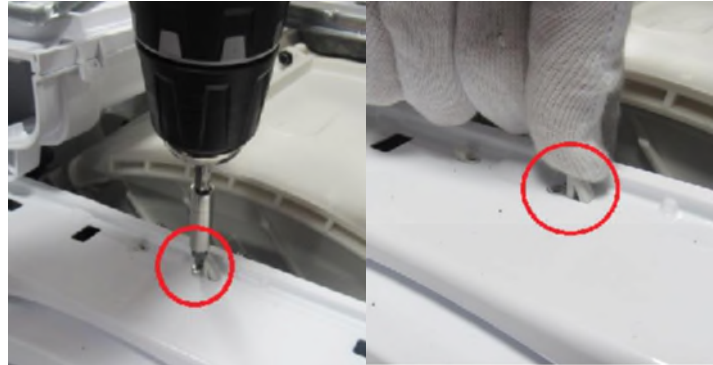

4.10 Assemble the twinjet elbow to the front panel



4.11 Tighten the screw on support bracket and two screws fixing front panel to body



4.12 Tighten two screws fixing control panel.



4.13 Tighten the screw which fixes the control panel to the front panel.

TUB BELLOW SEAL REPAIR INSTRUCTION

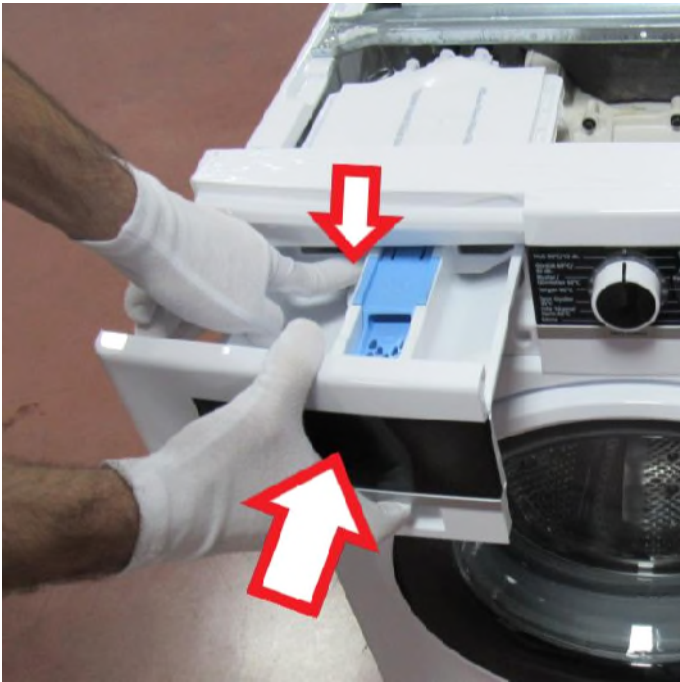

4.15 While pressing siphon cover keep pushing drawer to fit

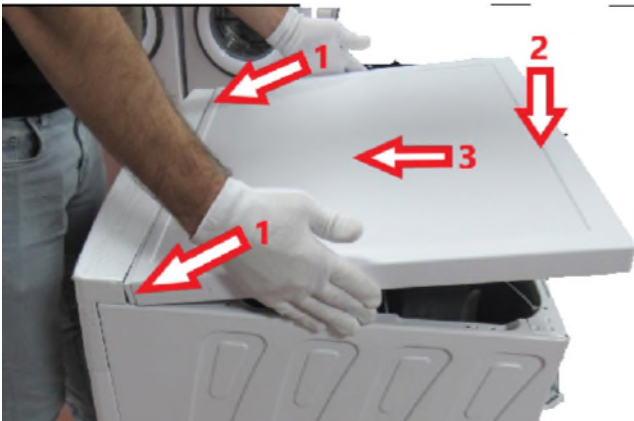

4.16 Fit the upper tray according to movement above

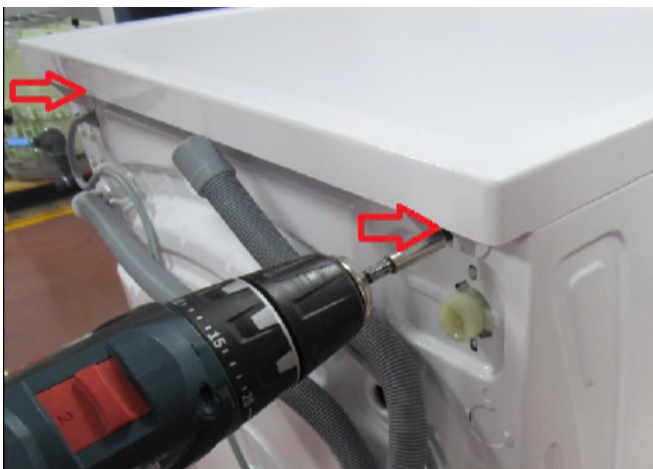

4.17 Tighten two screws that fix the top-plate at the back.

DOOR LOCK REPAIR INSTRUCTION

1. Disconnection



1.1 Remove the plug



1.2 Turn off the tap and disconnect the hose from the valve



1.3 Disconnect the drain hose

2. Necessary Tools



- A. Flat head thin screwdriver
- B. Torx T20
- C. Cordless screwdriver or classic screwdriver to use torx head (T20)

3. Disassembly Instructions



3.1 Remove the screws fixing the door lock.

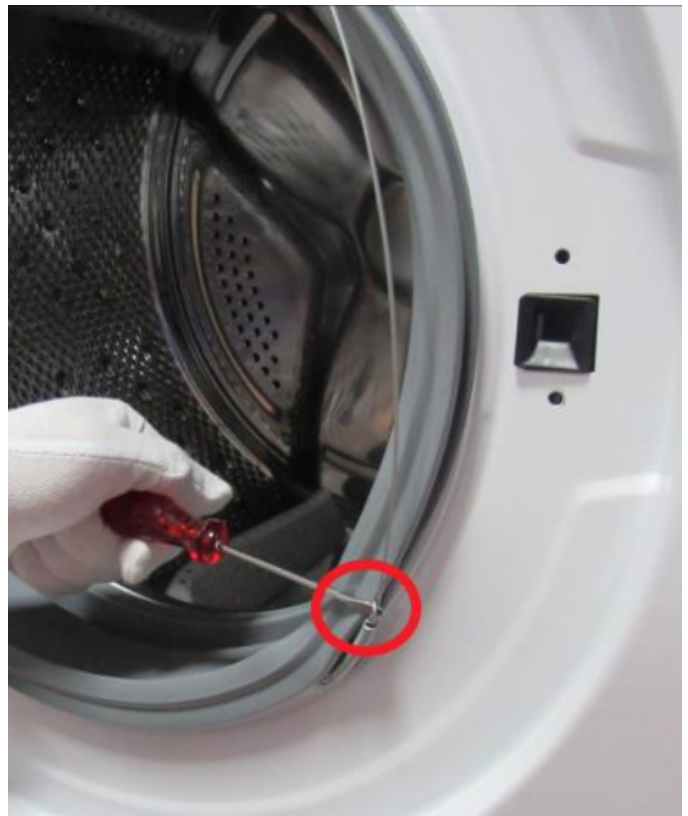

3.2 Remove the wire by using small screwdriver

DOOR LOCK REPAIR INSTRUCTION



3.3 Remove the right side of the tub bellows seal and reach to door lock

4. Assembly Instructions



4.1 Unplug the connector and remove the door lock. Connect the new door lock to connector.



4.3 Fix the tub bellow seal and fix the wire by using the small screwdriver



4.2 While supporting the door lock by hand, tighten the screws fixing the door lock.

REPLACEMENT PROCEDURE		Applicable models	EN
		General	
Part name	Pump		

SAFETY PRECAUTIONS



Before any disassembly/repair operation make sure appliance is unplugged, water tap is closed and heating elements are cooled down. There is electrical shock, burning and flood risk.



Please replace whole cable group even in case there is any minor failure with cables / terminals / sockets. Never try to repair nor to solder cable group. It may cause smoke, ignition and there is major risk of electrical shock.



Straightly pull out or insert the terminals.
Do not twist it. It may be the cause of damage or ignition.



Always use insulator gloves to prevent injury by metal edges or to prevent electrical shock during electrical tests.

Work with uniforms having long sleeves to protect your arms from metal edges.



Always use original spare parts. You may harm appliance, end user, environment or yourself using untested and unapproved 3rd party spare parts.



Use right tools to prevent any wear or damage to components during assembly/disassembly.



Do not touch any rotating object with hand unless it stops completely. Slow rotation may also roll in your hands and cause injury.



Rebuilding is prohibited. Do not rebuild machine parts and components when repairing service. It may be the cause of damage or ignition.

REPLACEMENT PROCEDURE		Applicable models	EN
		General	
Part name	Pump		

Necessary Tools



- A) Plier
- B) Flat head thin screwdriver
- C) Cordless screwdriver or classic screwdriver with torx head (T20)

1. Disconnection

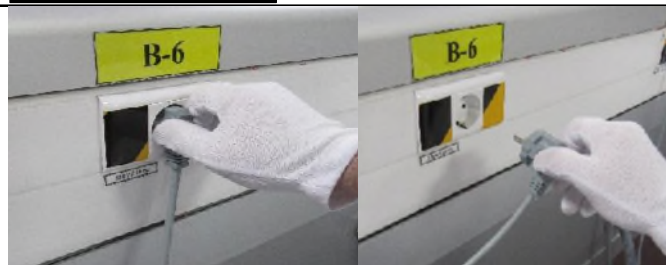

1.1. Remove the plug



1.2. Turn off the tap and disconnect the hose from the valve



1.3. Disconnect the drain hose

2) Disassembly Instructions

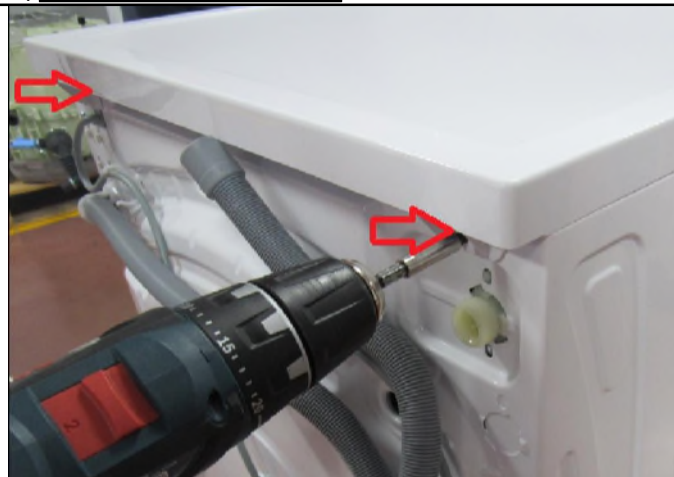

2.1. Remove two screws that fix the top-plate at the back.



2.2. Push the top-plate back and pull it up.

REPLACEMENT PROCEDURE		Applicable models	EN
Part name	Pump	General	

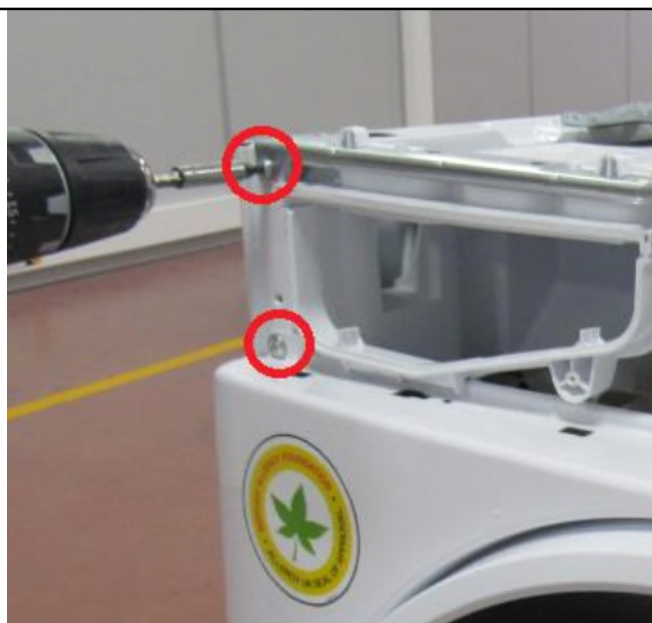
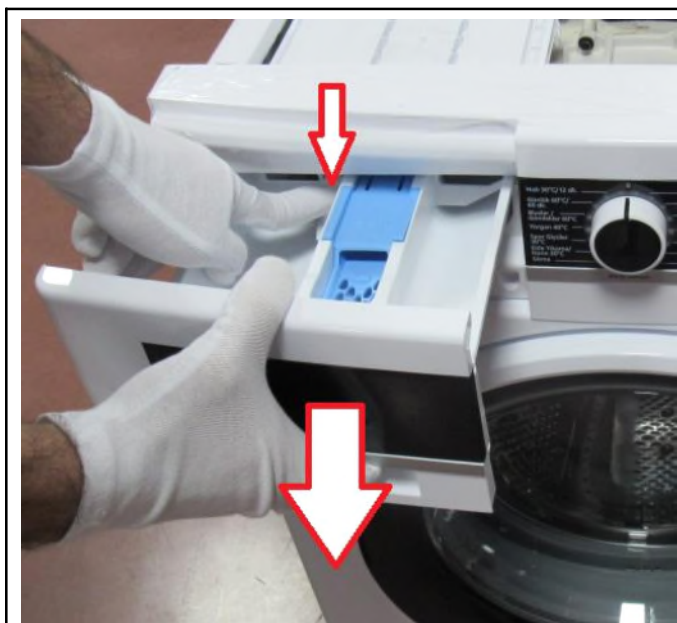

2.3. While pressing siphon cover keep pulling drawer to remove it.

2.4. Remove the screw on support bracket and two screws fixing front panel to body



2.5. Remove the screw fixing twinjet elbow.

2.6. Remove the screws fixing the door lock.

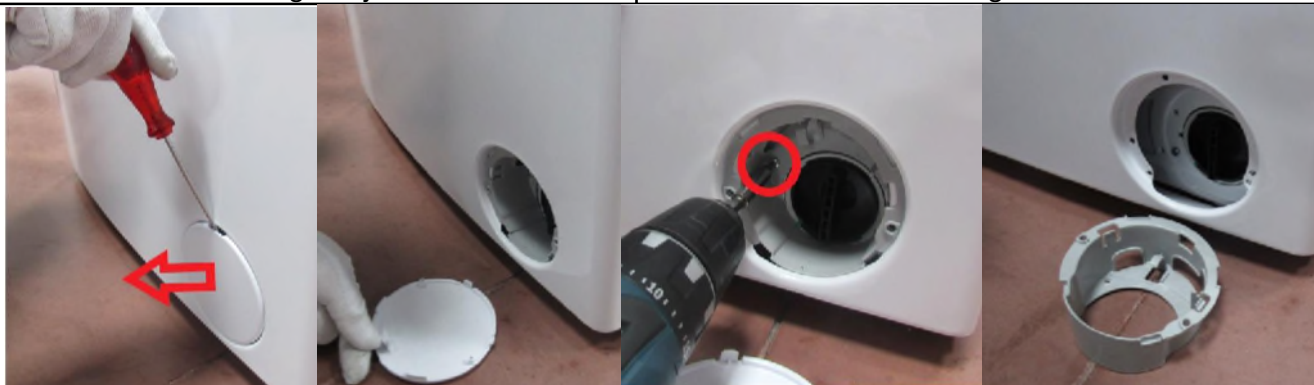

2.7. Remove the screw and plastic part located under the pump cover

REPLACEMENT PROCEDURE		Applicable models	EN
		General	
Part name	Pump		

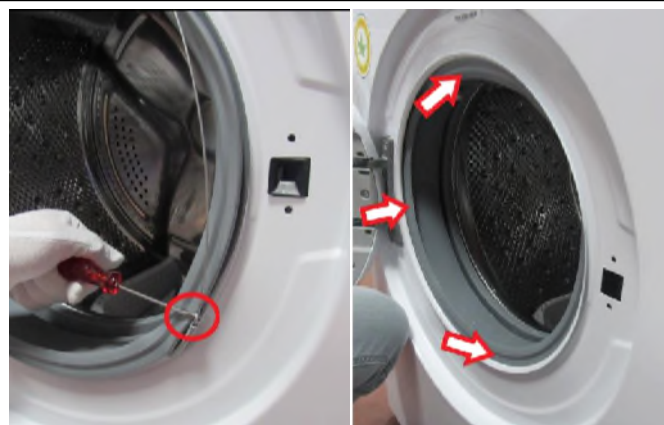

2.8. Remove the screw fixing the front panel at the bottom.

2.9. Remove the wire by using small screwdriver and push the seal to the inside

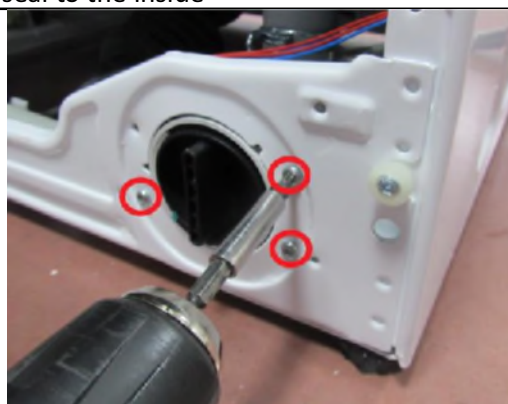

2.10. Pull up and remove the front panel.

2.11. Remove screws holding drain pump

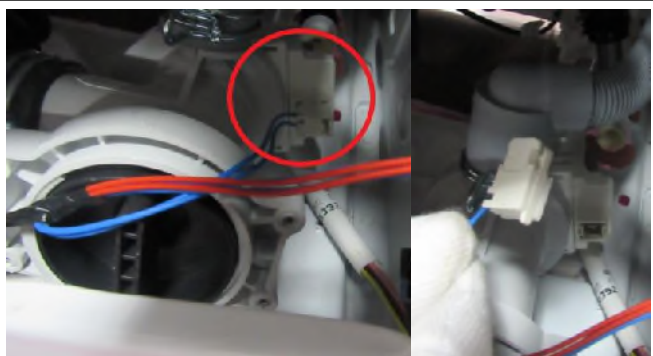

2.12. Remove the drain pump connector

2.13. Remove clamp fixing tub outlet hose by using a plier



2.14. Remove clamp holding drain hose by using a plier.

2.15. Remove clamp holding twinjet hose by using a plier.

REPLACEMENT PROCEDURE		Applicable models	EN
		General	
Part name	Pump		



2.16. Remove the drain pump and change with the new one

3. Assembly Instructions



3.1. Connect the twinjet hose by using a plier to fix the clamp

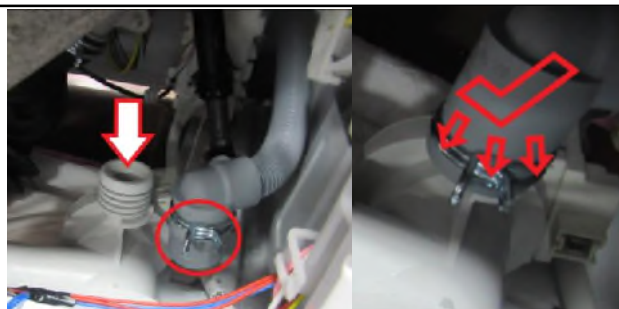

3.2. Connect the drain hose by using a plier to fix the clamp

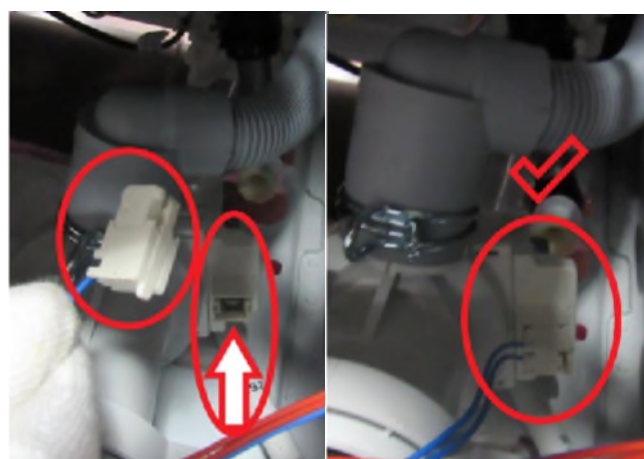

3.3. Connect the drain pump connector

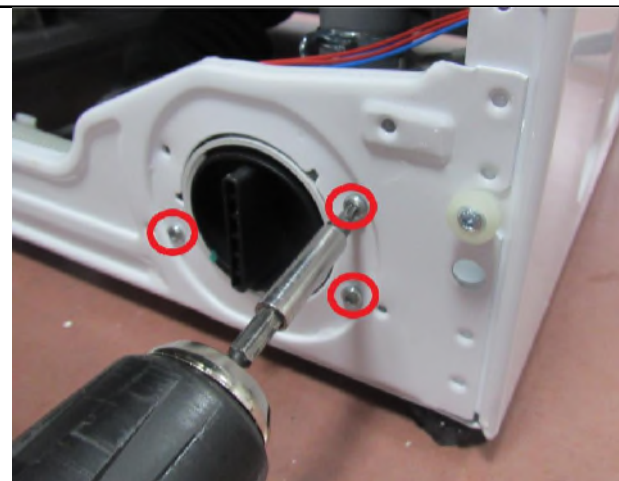

3.4. Tighten the screws holding drain pump

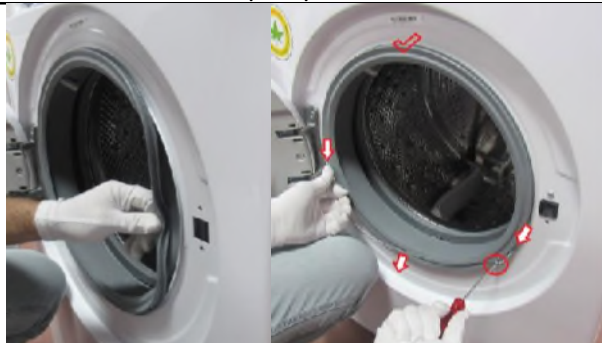

3.5. Pull the tub bellow seal to the outside and assemble the wire by using small screwdriver



3.6. Tighten the screw fixing the front panel at the bottom

REPLACEMENT PROCEDURE		Applicable models	EN
		General	
Part name	Pump		

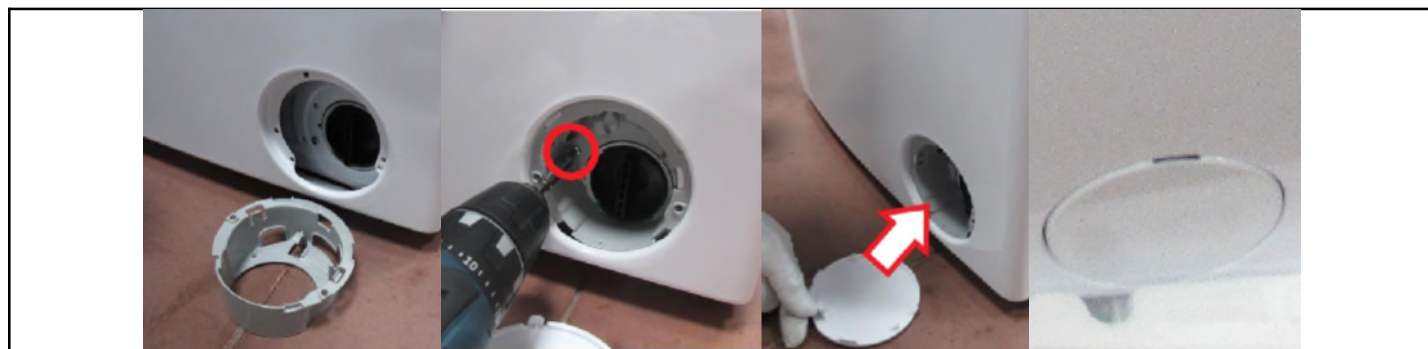

3.7. Tighten the screw and plastic part located under the pump cover

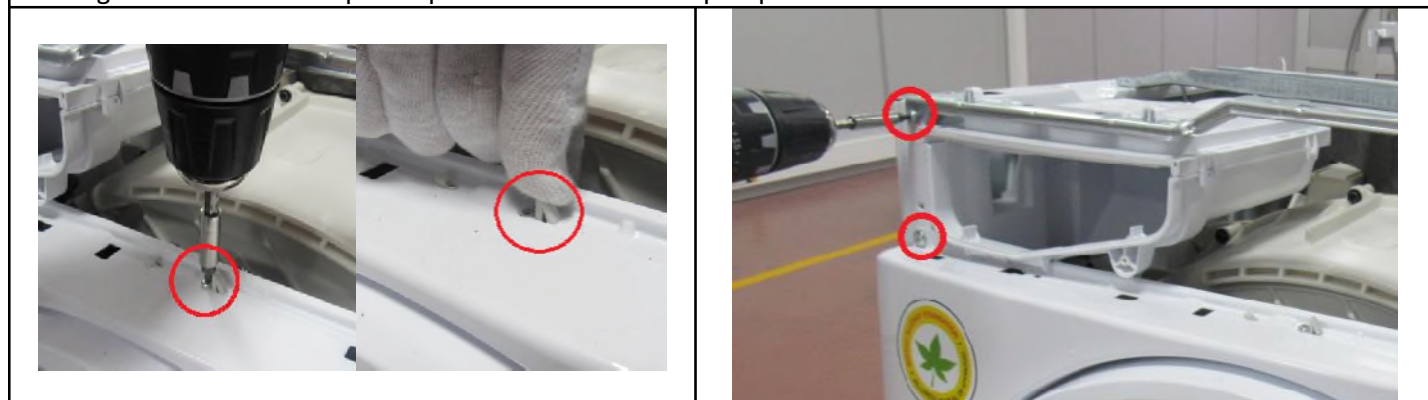

3.8. Assemble the twinjet elbow to the front panel

3.9. Tighten the screw on support bracket and two screws fixing front panel to body



3.10. Tighten two screws fixing control panel.

3.11. Tighten the screw which fixes the control panel to the front panel.

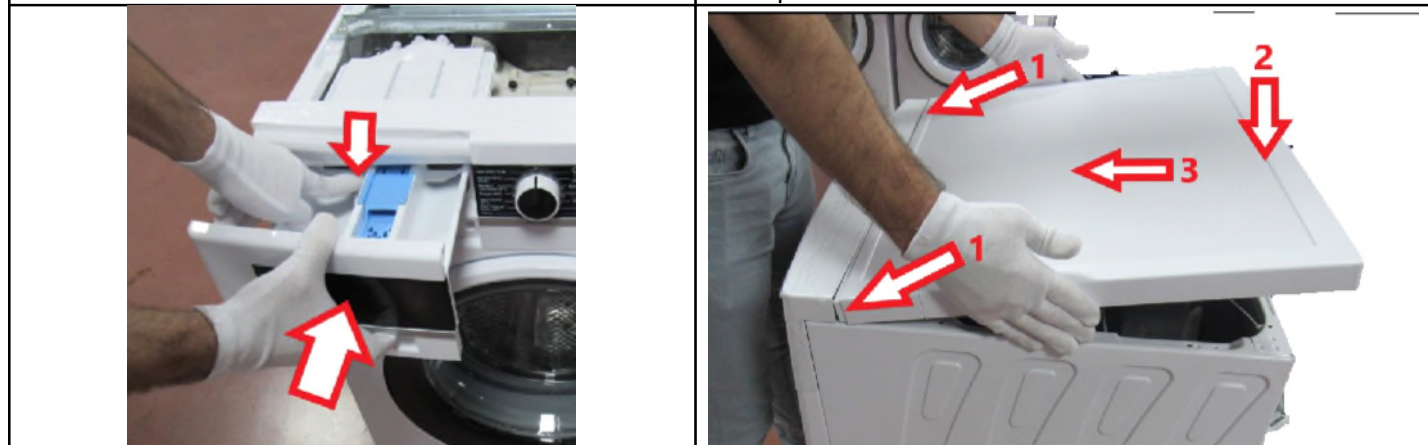

3.12. While pressing siphon cover keep pushing

3.13. Fit the upper tray according to movement above

REPLACEMENT PROCEDURE		Applicable models	EN
Part name	Pump	General	

drawer to fit it.

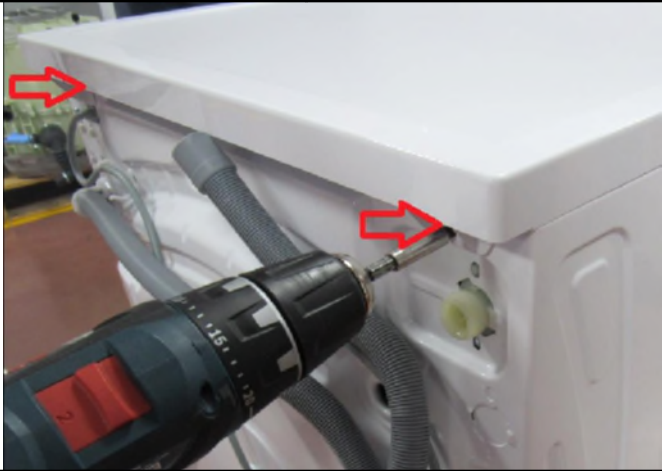

3.14. Tighten two screws that fix the top-plate at the back

PCB REPAIR INSTRUCTION

1. Disconnection



1.1 Remove the plug



1.2 Turn off the tap and disconnect the hose from the valve



1.3 Disconnect the drain hose

2. Necessary Tools



- A. Cordless screwdriver with torx T20 head
- B. or classic screwdriver with torx T20 head
- C. Flat head thin screwdriver

3. Disassembly Instructions

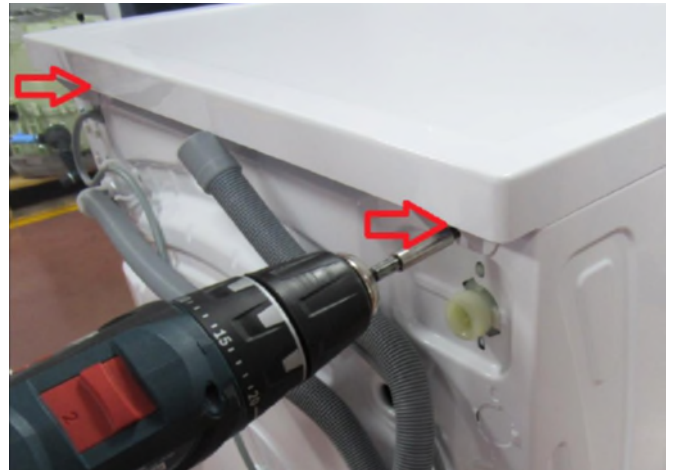

3.1 Remove two screws that fix the top-plate at the back.

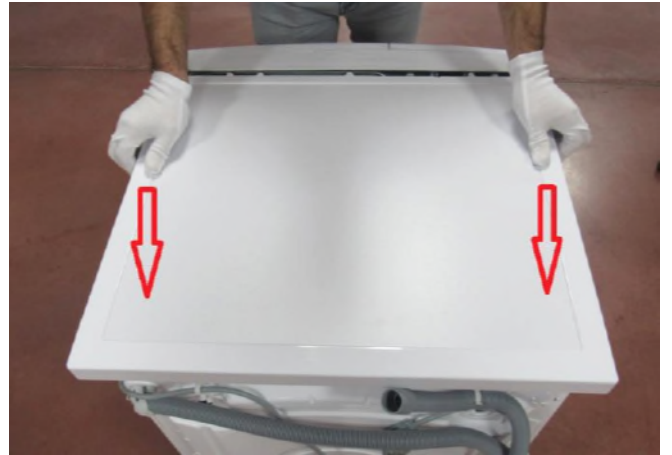

3.2 Push the top-plate back and pull it up.

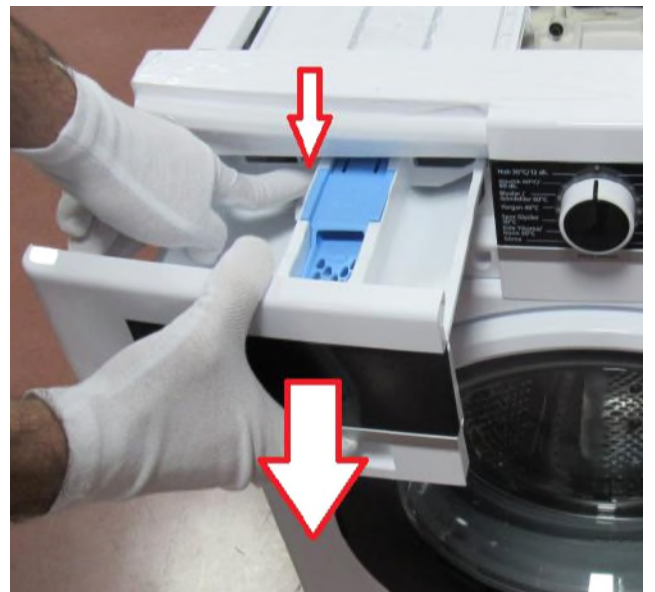

3.3 While pressing siphon cover keep pulling drawer to remove it.

PCB REPAIR INSTRUCTION



3.4 Remove the screw which fixes the control panel to the front panel.

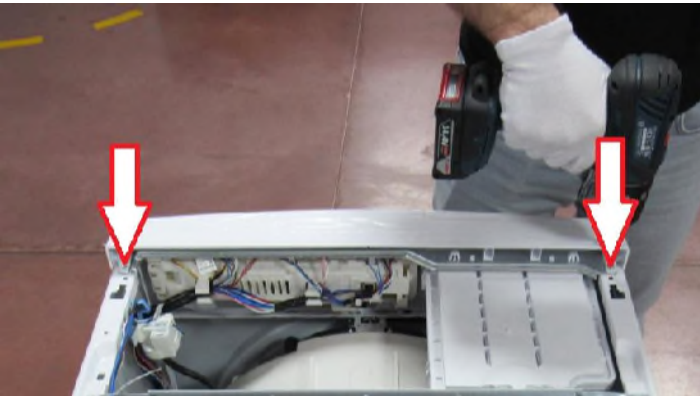

3.5 Remove two screws fixing control panel.



3.6 Remove the sockets on the card.

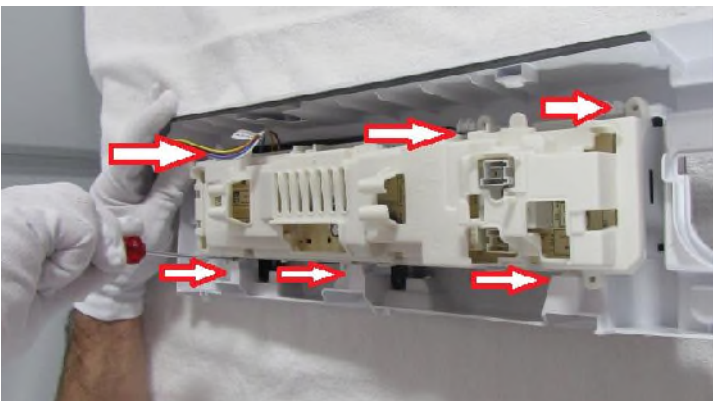

3.7 Depress the taps fixing the card by using a screwdriver



3.8 After releasing sockets, remove PCB box from its housing

4. Assembly Instructions

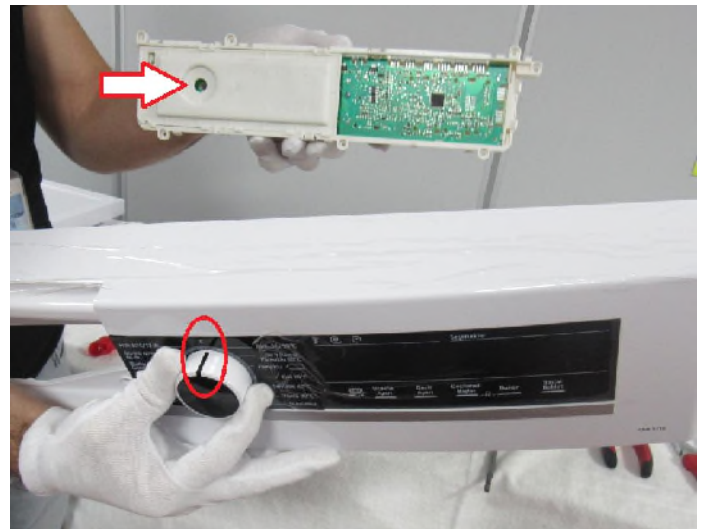

4.1 Be sure the kbon is in the "zero" position

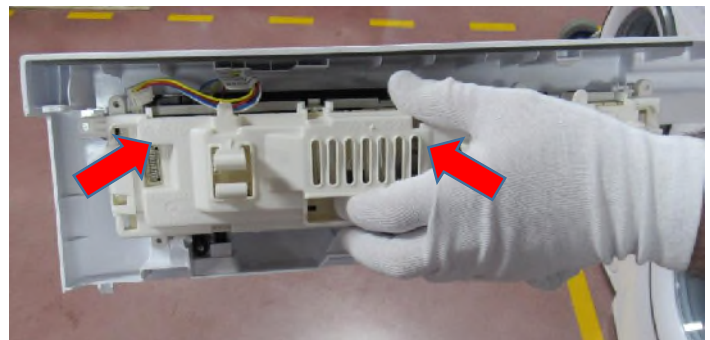

4.2 Push the PCB box and fit to the housing

PCB REPAIR INSTRUCTION

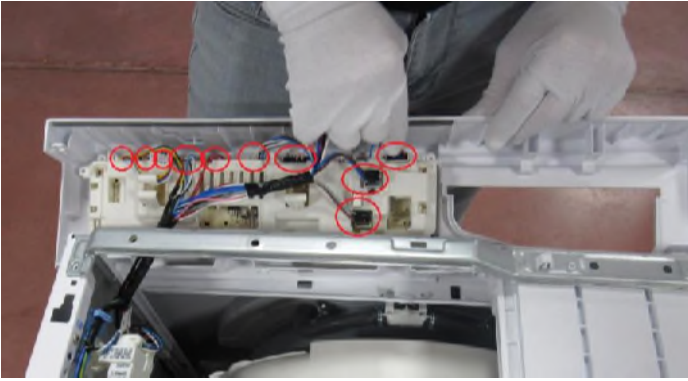

4.3 Connect the all sockets on the card according to the wiring diagram.

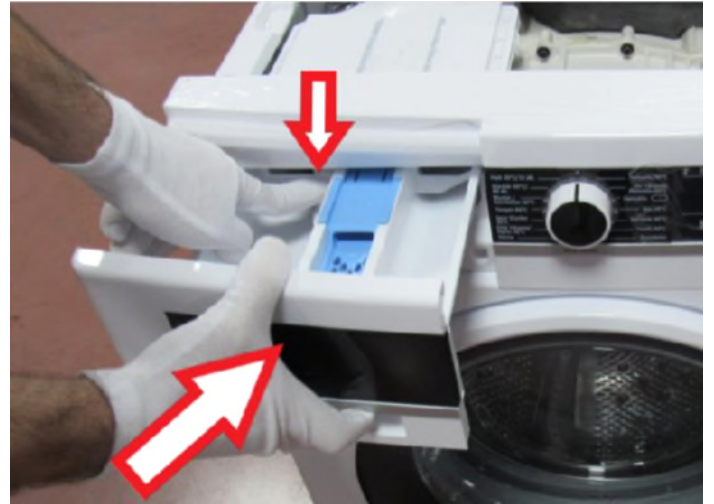

4.6 While pressing siphon cover keep pushing drawer to assemble it.



4.4 Tighten the two screws on control panel.

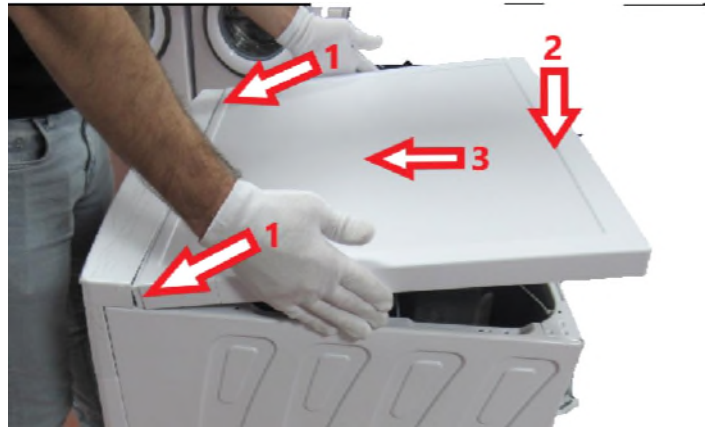

4.7 Fit the upper tray according to movement above



4.5 Tighten the screw which fixes the control panel to the front panel.

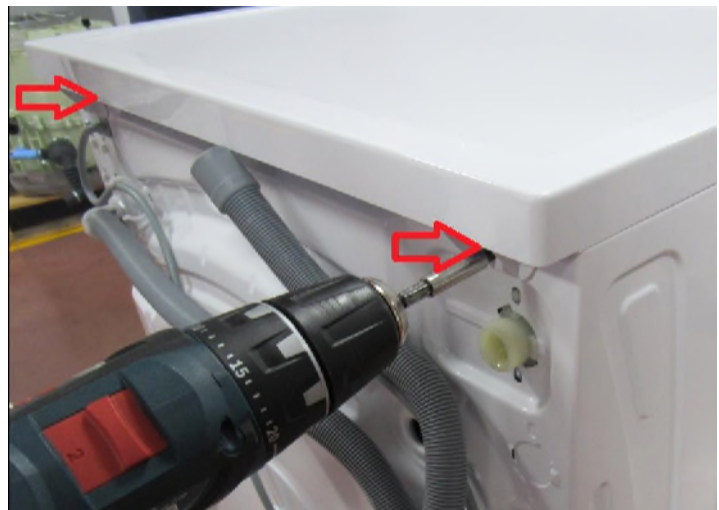

4.8 Tighten two screws that fix the top-plate at the back.

HEATER REPAIR INSTRUCTION

1. Disconnection



Remove the plug



Turn off the tap and disconnect the hose from the valve



Disconnect the drain hose

2. Necessary Tools



A. Plier

B. Flat head screwdriver

C. Ratchet Wrench with M8 head

3. Disassembly Instructions

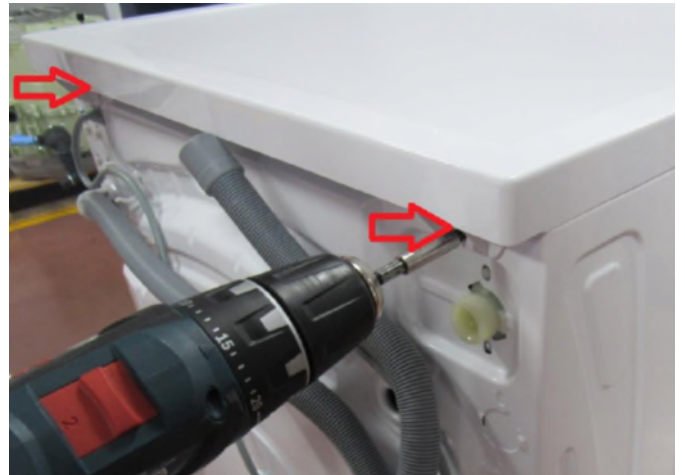

Remove two screws that fix the top-plate at the back.

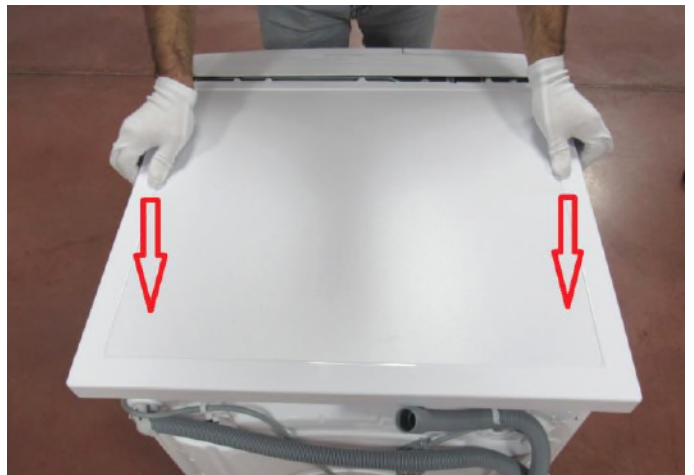

Push the top-plate back and pull it up.

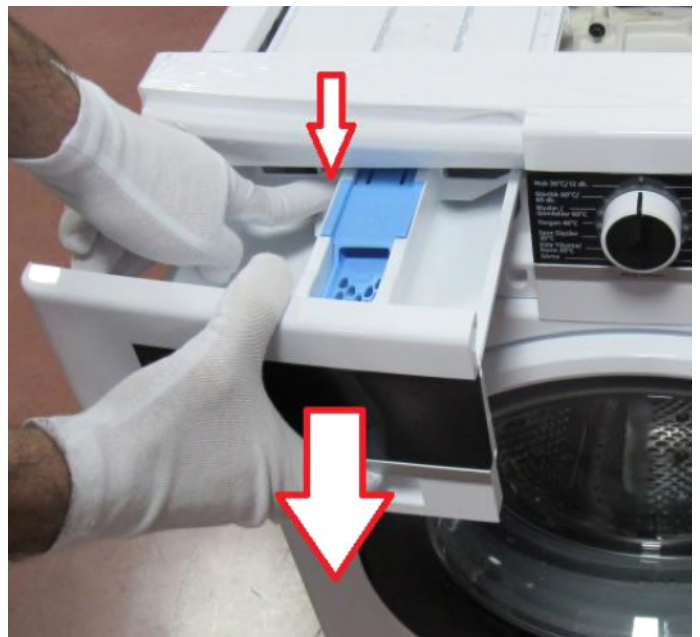

While pressing siphon cover keep pulling drawer to remove it.

HEATER REPAIR INSTRUCTION



Remove the screw which fixes the control panel to the front panel.

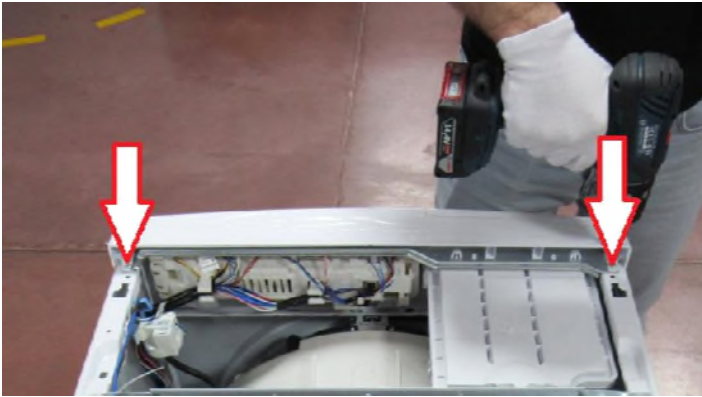

Remove two screws fixing control panel.



Remove the screw on support bracket and two screws fixing front panel to body

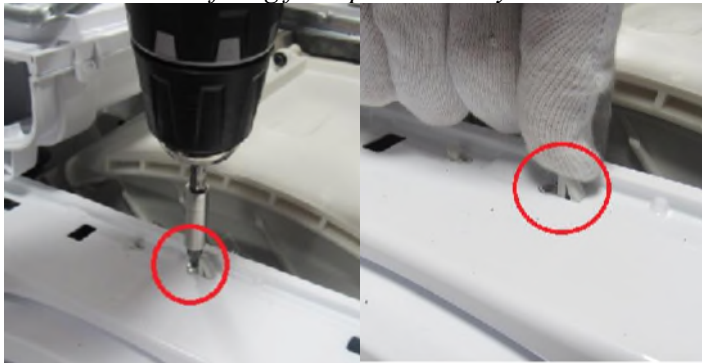

Remove the screw fixing twinjet elbow.



Remove the screws fixing the door lock.

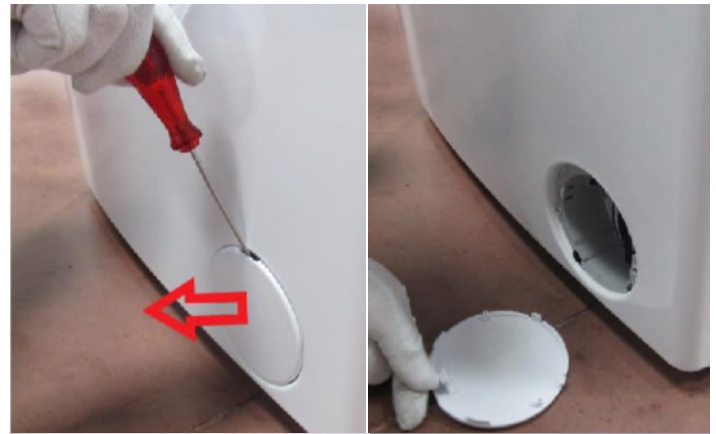

Remove the screw and plastic part located under the pump cover

HEATER REPAIR INSTRUCTION



Remove the screw fixing the front panel at the bottom.

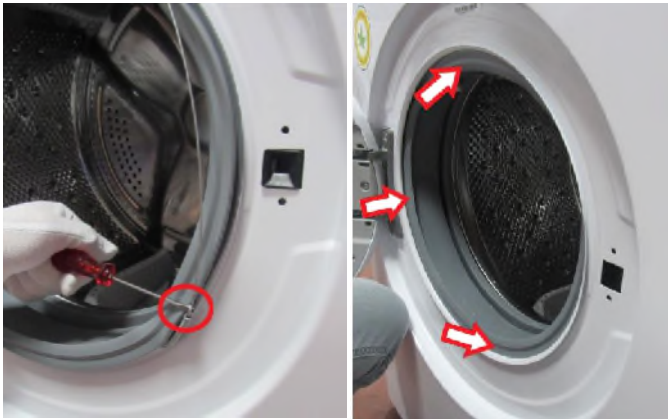

Remove the wire by using small screwdriver and push the seal to the inside



Pull up and remove the front panel.

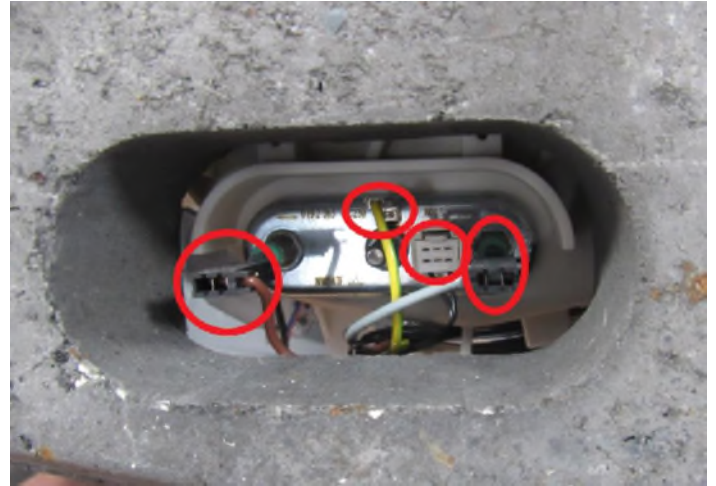

Remove the heater sockets

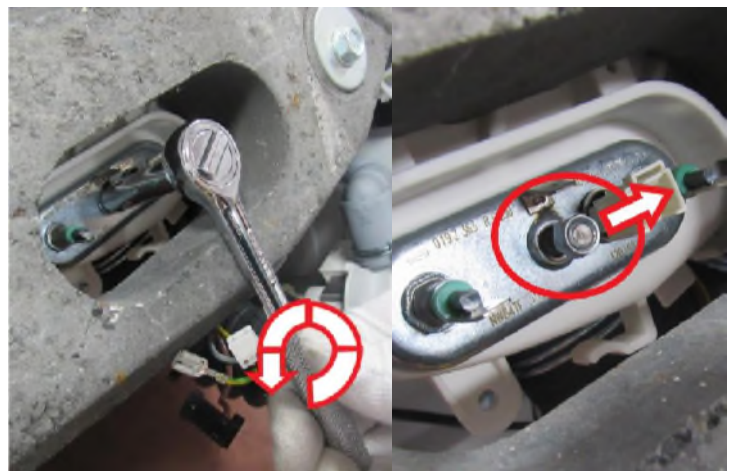

HEATER REPAIR INSTRUCTION

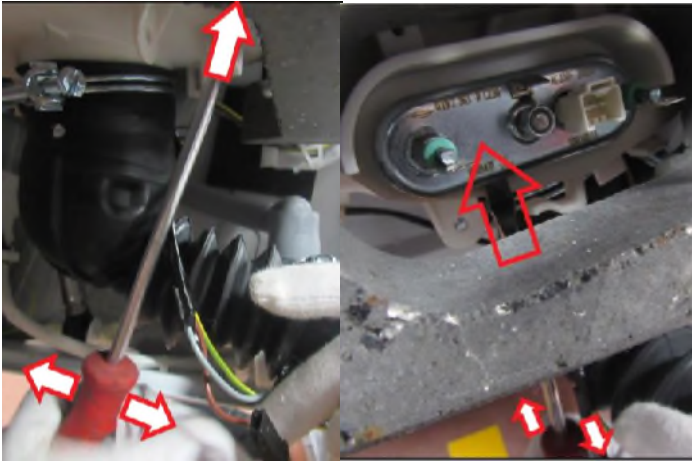

4. Assembly Instructions

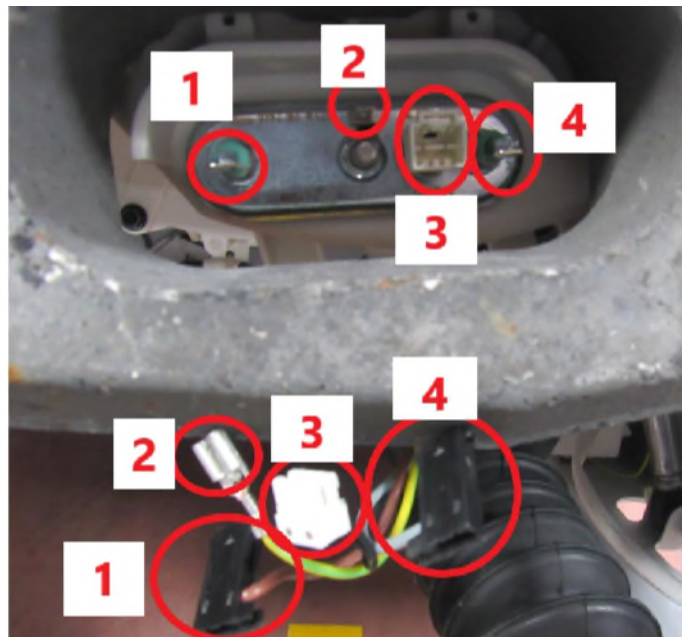
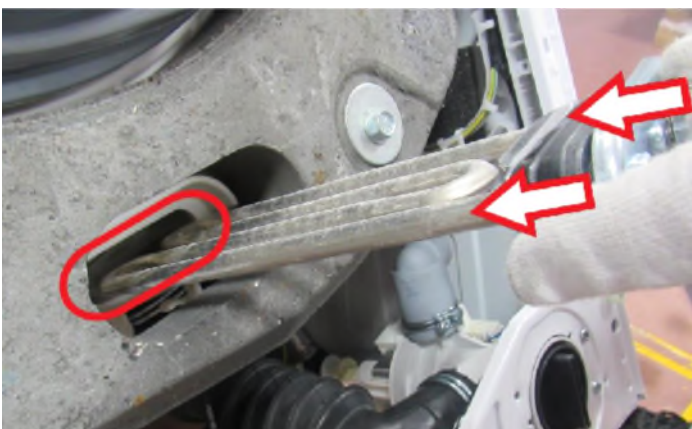

HEATER REPAIR INSTRUCTION

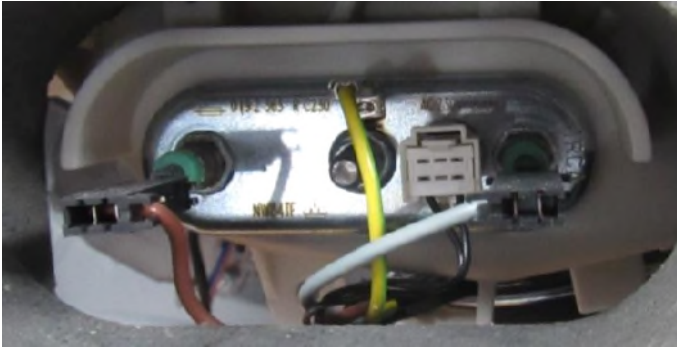

Pull the tub bellow seal to the outside and assemble the wire by using small screwdriver

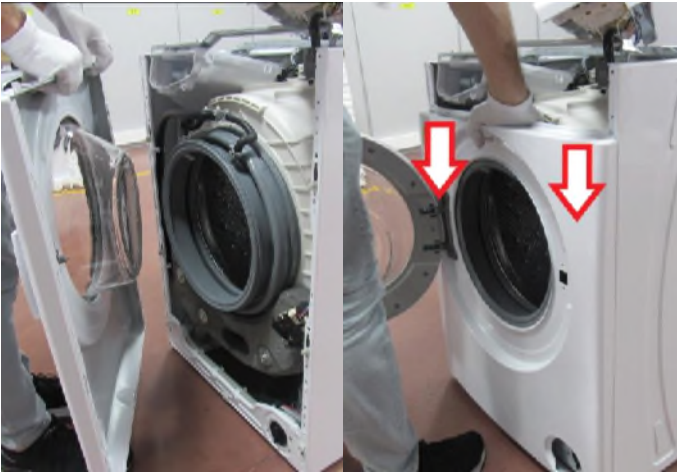

Put the front panel to the cabinet and push down to set it



Tighten the screw fixing the front panel at the bottom



Tighten the door lock screw

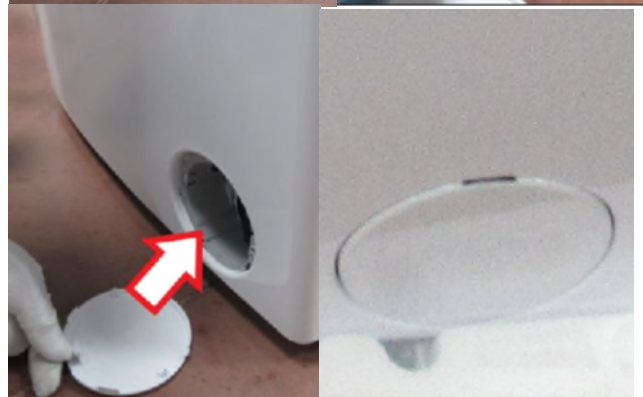

HEATER REPAIR INSTRUCTION

Tighten the screw and plastic part located under the pump cover

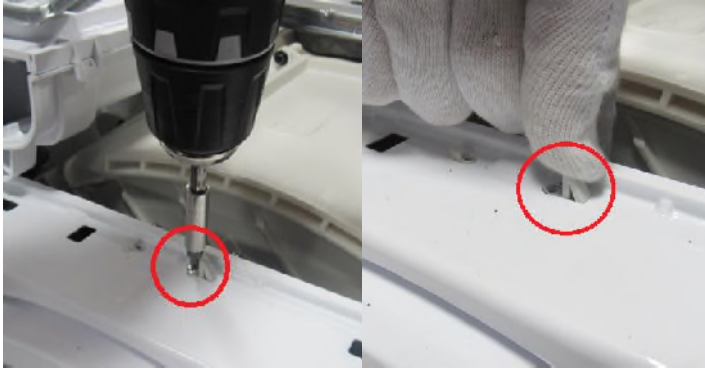

Assemble the twinjet elbow to the front panel

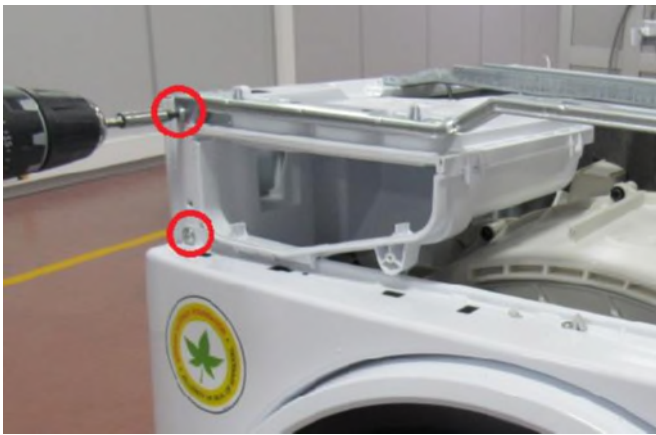

Tighten the screw on support bracket and two screws fixing front panel to body



Tighten two screws fixing control panel.



Tighten the screw which fixes the control panel to the front panel.

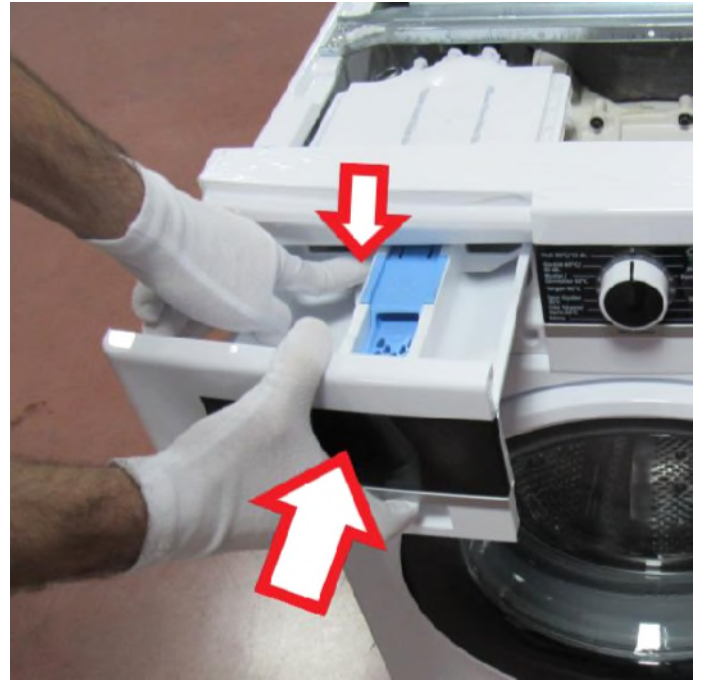

While pressing siphon cover keep pushing drawer to fit it



Fit the upper tray according to movement above

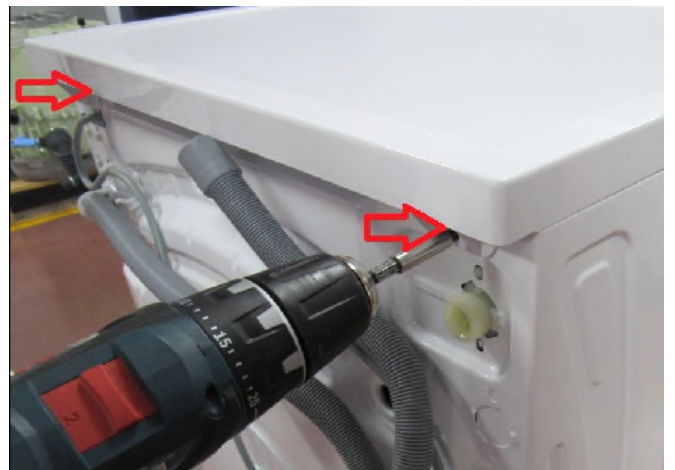

Tighten two screws that fix the top-plate at the back.

REPLACEMENT PROCEDURE		Applicable models	EN
		General	
Part name	Door, Hinge ve Handle		

SAFETY PRECAUTIONS



Before any disassembly/repair operation make sure appliance is unplugged, water tap is closed and heating elements are cooled down. There is electrical shock, burning and flood risk.



Please replace whole cable group even in case there is any minor failure with cables / terminals / sockets. Never try to repair nor to solder cable group. It may cause smoke, ignition and there is major risk of electrical shock.



Straightly pull out or insert the terminals.
Do not twist it. It may be the cause of damage or ignition.



Always use insulator gloves to prevent injury by metal edges or to prevent electrical shock during electrical tests.

Work with uniforms having long sleeves to protect your arms from metal edges.



Always use original spare parts. You may harm appliance, end user, environment or yourself using untested and unapproved 3rd party spare parts.



Use right tools to prevent any wear or damage to components during assembly/disassembly.



Do not touch any rotating object with hand unless it stops completely. Slow rotation may also roll in your hands and cause injury.

REPLACEMENT PROCEDURE		Applicable models	EN
		General	
Part name	Door, Hinge ve Handle		



Rebuilding is prohibited. Do not rebuild machine parts and components when repairing service. It may be the cause of damage or ignition.

Necessary Tools



- A) Plier
- B) Flat head thin screwdriver
- C) Cordless screwdriver or classic screwdriver with torx head (T25)





1. Disconnection

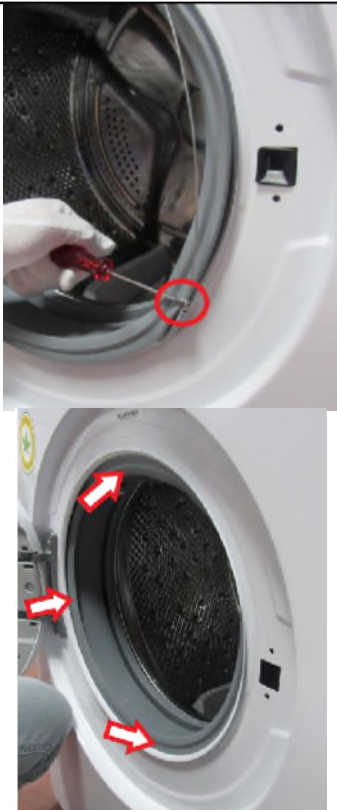

Remove the plug

2) Disassembly Instructions

REPLACEMENT PROCEDURE		Applicable models	EN
		General	
Part name	Door, Hinge ve Handle		

	
<p>2.1. Remove the wire by using small screwdriver and push the seal to the inside</p>	<p>2.2. Remove the door hinge screws by using a Tx25 head screwdriver</p>
	
<p>2.3. Remove the door</p>	<p>2.4. There is hinge support sheet behind the front panel. Please keep it stable while operation and do not forget to assemble it to the front panel.</p>
<p>Follow the hinge and handle changing instructions if needed after this step. If not required to replace the hinge and handle, you can skip to the door assembly section.</p>	

REPLACEMENT PROCEDURE		Applicable models	EN
		General	
Part name	Door, Hinge ve Handle		



2.5. Remove the screws on the door, a number of the screws may change based on the door type.



2.6. You can use a screwdriver to separate the front and back plastics from the area in the photo.

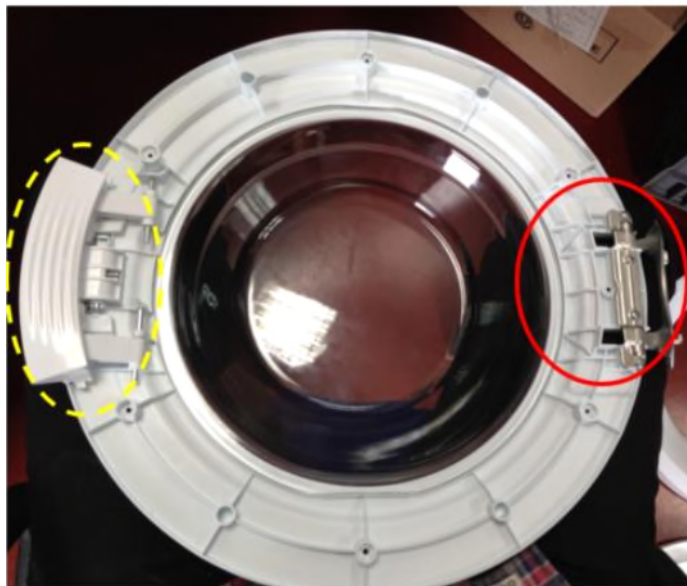

2.7. Remove the plastic parts as shown in the photo above.

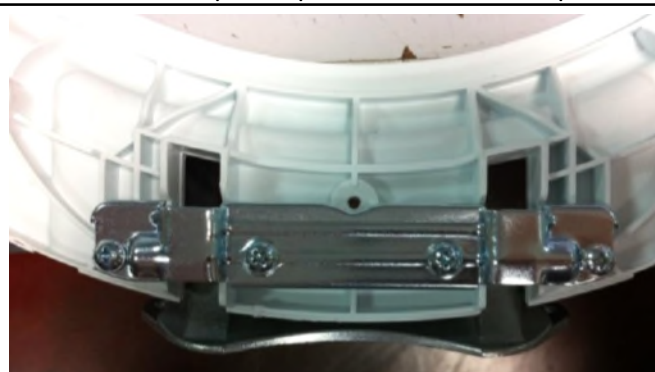
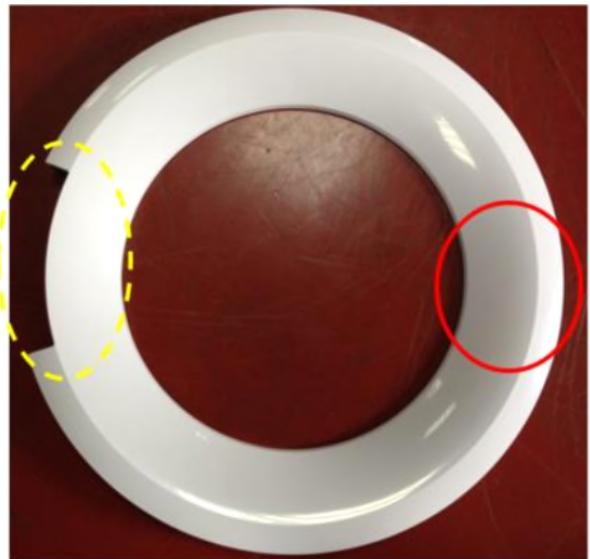

2.8. Remove the hinge sheet by screwdriver

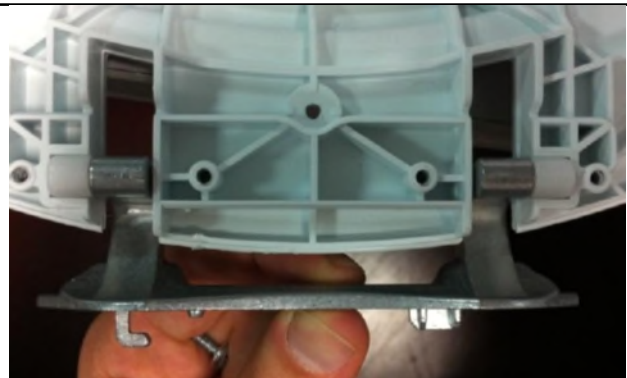

2.9. Remove the hinge

IF THE PRODUCT HAS PLASTIC HINGE PLEASE FOLLOW THE INSTRUCTIONS BELOW

REPLACEMENT PROCEDURE		Applicable models	EN
		General	
Part name	Door, Hinge ve Handle		



2.10. Hinge needs to be changed as a group for the door which has no handle.

2.11. Remove the screws and assemble the new part as a group.

DISASSEMBLY FOR THE OUTSIDE HANDLE

DISASSEMBLY FOR THE INSIDE HANDLE

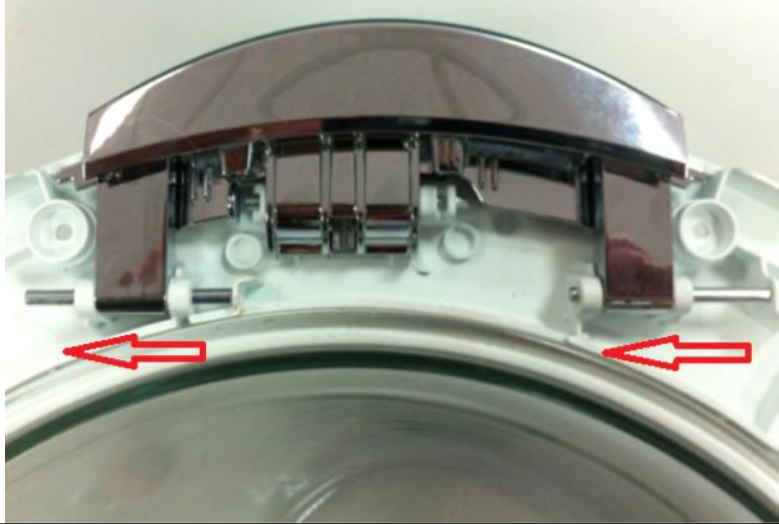

2.12. Remove the pins in the direction of the arrows

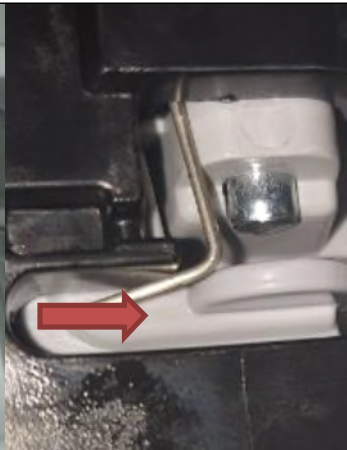

REPLACEMENT PROCEDURE		Applicable models	EN
		General	
Part name	Door, Hinge ve Handle		

2.13. Remove the spring from the hosue (depends on the model)

INSIDE HANDLE DISASSEMBLY



2.14. Remove the pin in the direction of the arrow.

2.15. Use the knife or thin flat head screwdriver to remove the pin.



2.16. Take the pin by a plier. Then please take off the door handle and assemble the new one.

3. Assembly Instructions

Please pay attention to intructions according to the door handle type. If you have not dropped the hinge support sheet to inside the machine, you can skip the tub bellow seal disassembly step.

REPLACEMENT PROCEDURE		Applicable models	EN
		General	
Part name	Door, Hinge ve Handle		



3.1 Remove the wire by using small screwdriver and push the seal to the inside



3.2 Push the seal to the inside



3.3 Take the hinge support sheet



3.4 Fit the hinge support sheet to the housing on the front panel.

DOOR HINGE ASSEMBLY INSTRUCTIONS (Please follow the instructions which is related to your type)

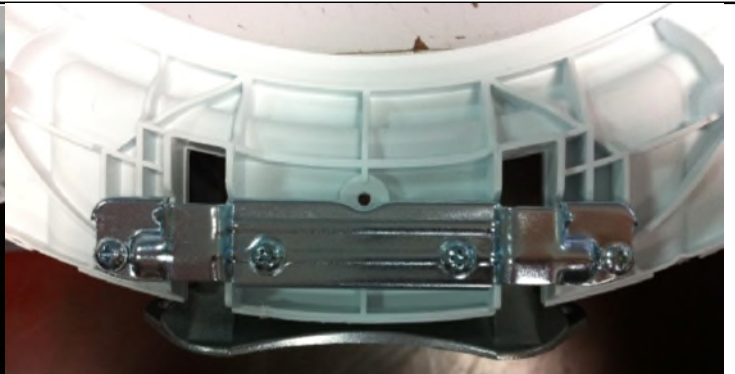
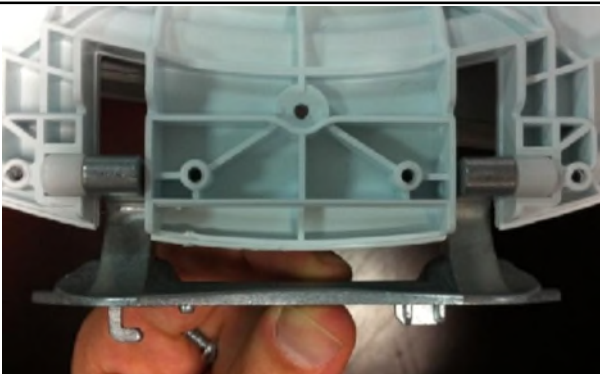

3.5 Fit the door hinge to the housing on the door and place the hinge sheet over it. The screw number may change depends on the door model.

REPLACEMENT PROCEDURE		Applicable models	EN
Part name	Door, Hinge ve Handle	General	



3.6 If the hinge on your product is the same as the photo above, you must change it as a group since it is not possible to remove the pin.

DOOR HANDLE ASSEMBLY (Please follow the instructions suitable for your models)

Assembly Instructions for the handle form inside

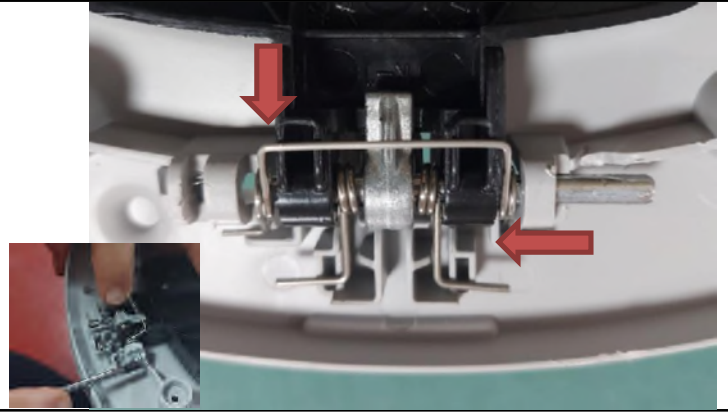

3.7 Place the parts as like photo above

3.8 Fit the pin to the house and as shown in the photo above.

Dıştan tutamaklı Kapı Tutamağı Montajı



3.9 Please follow the instructions as like in the photos. Place the springs to the houses on the door frame.

REPLACEMENT PROCEDURE		Applicable models	EN
		General	
Part name	Door, Hinge ve Handle		

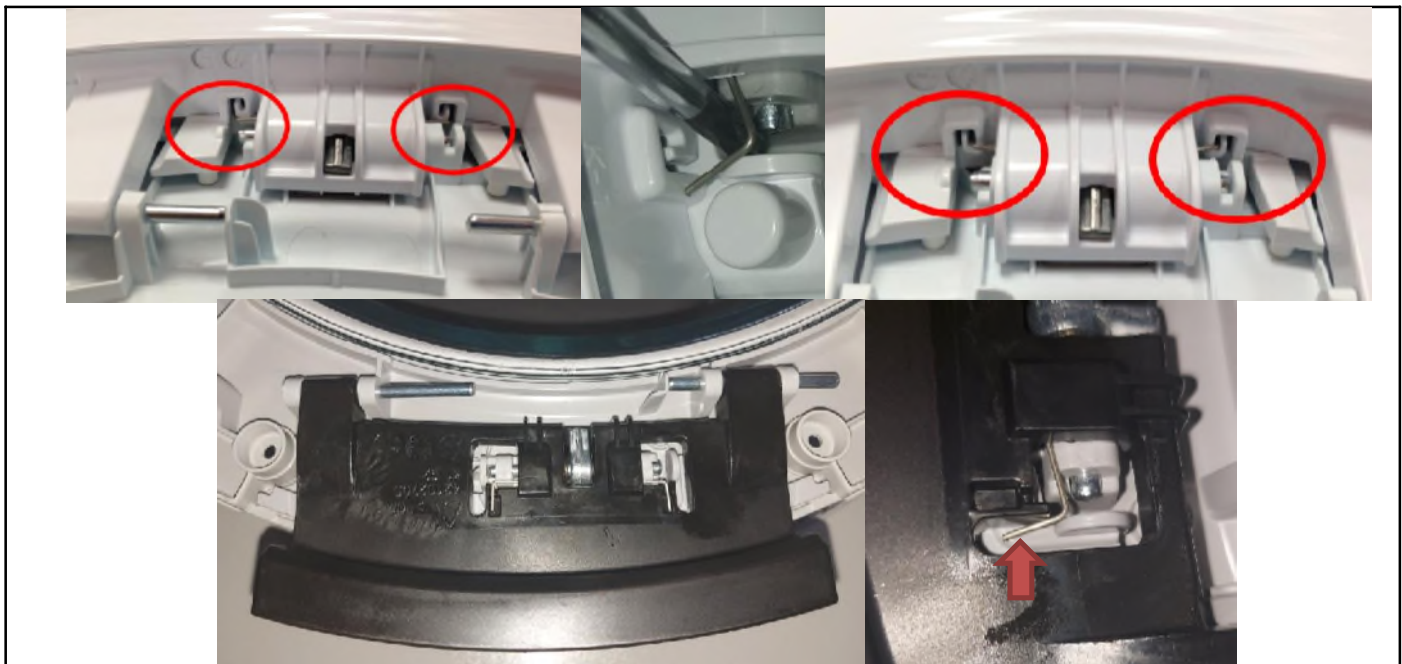

3.10 After fitting the handles, springs needs to be assemble to the handle as shown the photos above.

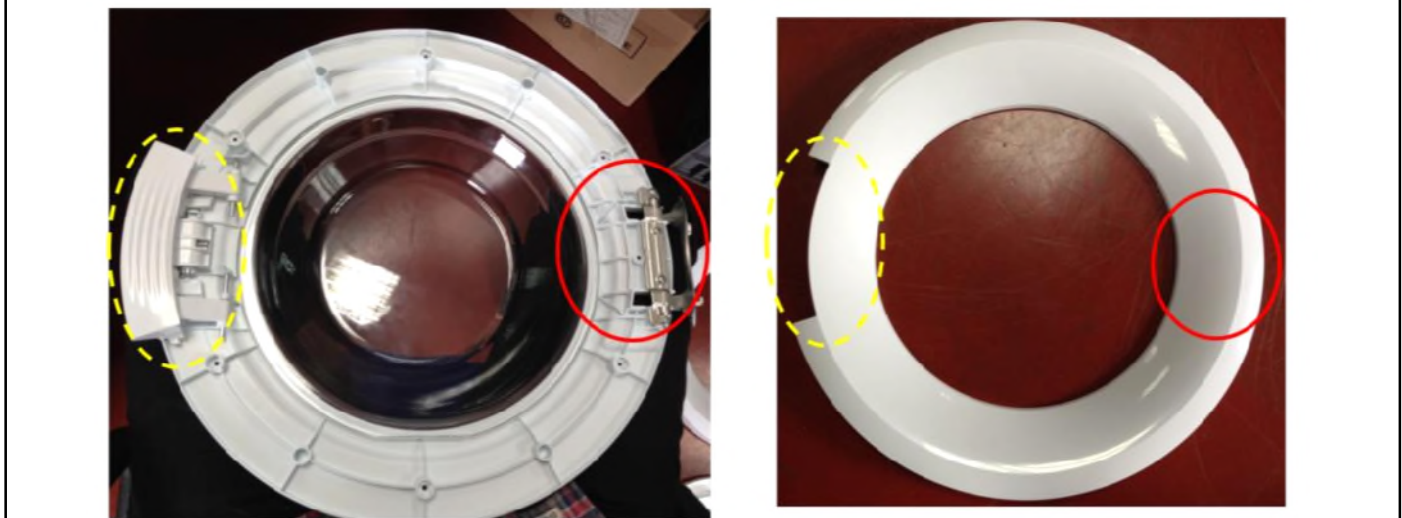

3.11 After the assembly of the handle or hinge, door outer plastic should be fitted. Please do not forget the assembly of the door glass too.



3.12 Be sure that all the parts have been fitted very well.

3.13 Assemble the all screws on the inside plastic part of the door.

REPLACEMENT PROCEDURE		Applicable models	EN
		General	
Part name	Door, Hinge ve Handle		

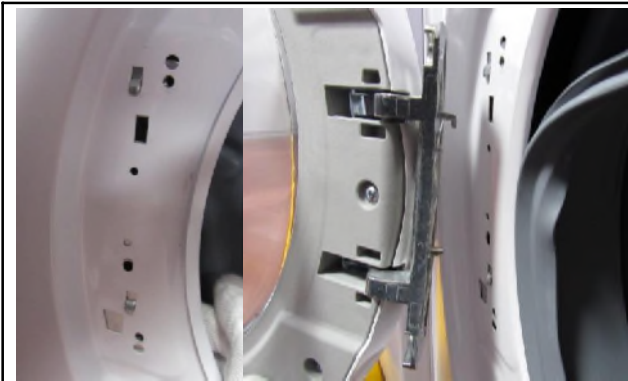

3.14 If the hinge support sheet had fallen inside to unit, please follow the related previous instructions to fit it to the front panel firstly. After that assemble the door to the front panel

3.15 Tighten the hinge screw by using a Tx25 screwdriver.

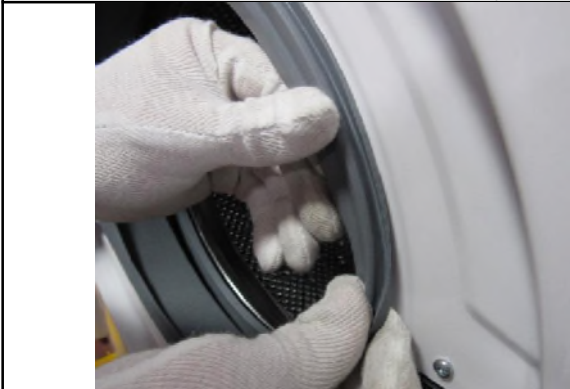

3.16 If the tub bellow seals had removed before, please assemble it again.

3.17 Place the seal spring and fit to the housing on the front panel.



3.18 Spring must be fitted very well as shown in the photo above.