

OPTIONAL WITH SIDE PANEL LED

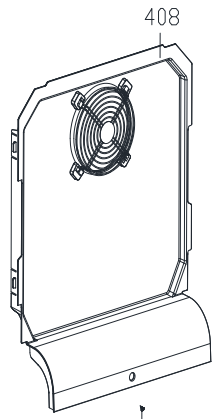

431-B

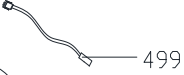
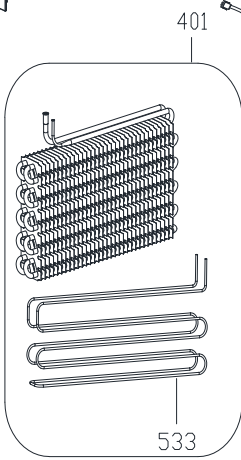
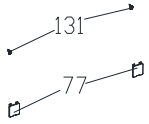
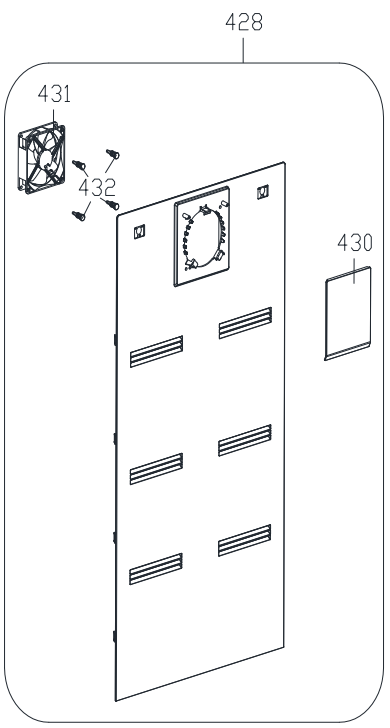
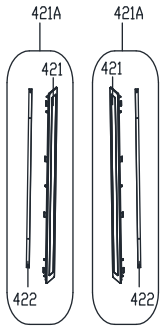
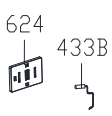

70

154

189

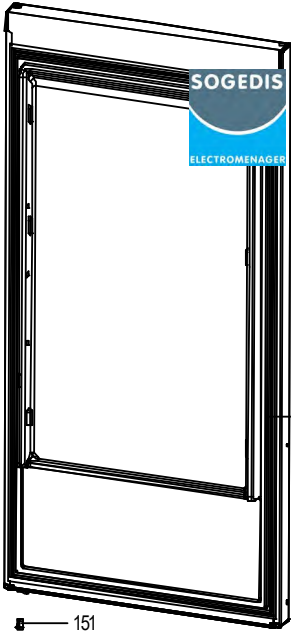
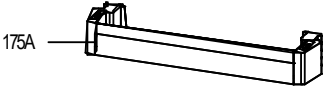
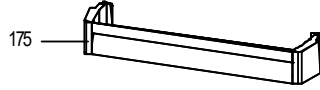
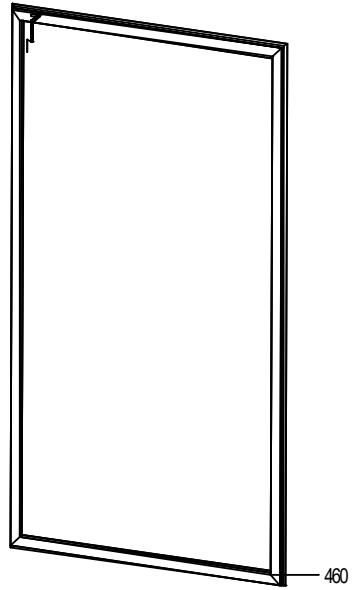

151
173
171

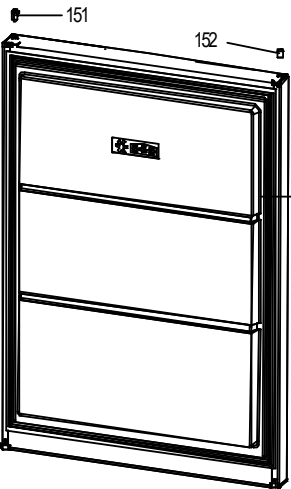
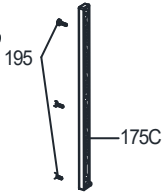
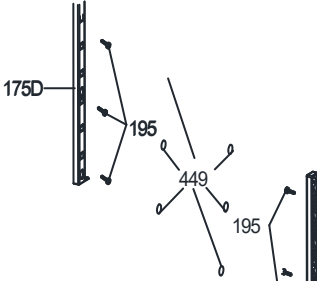

151

152

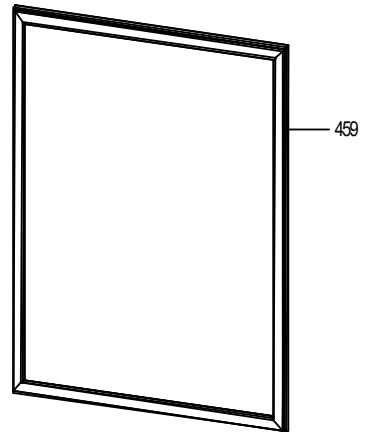

174B
187

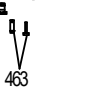

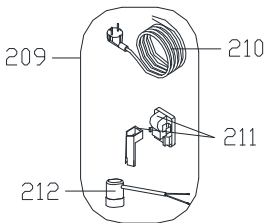
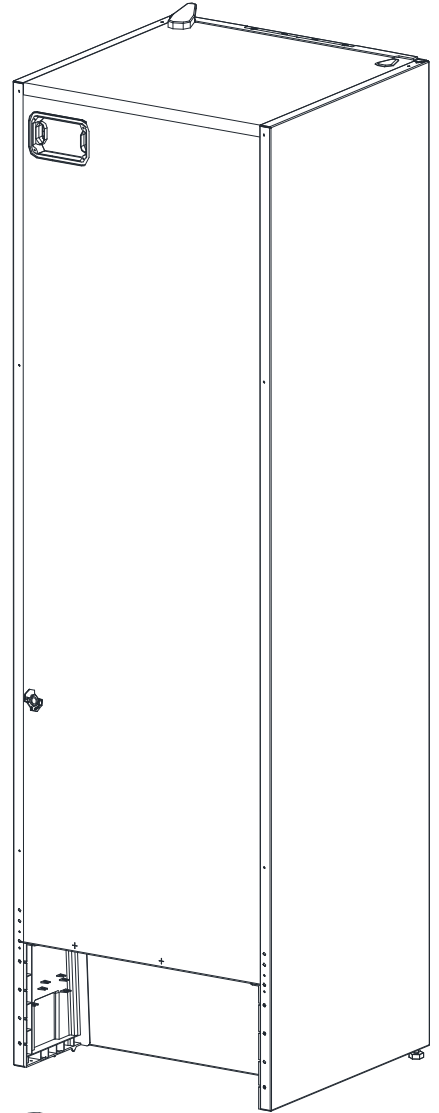
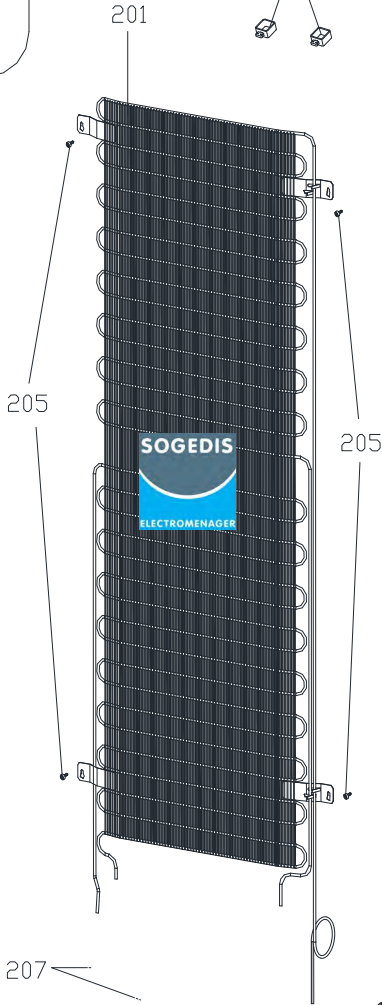
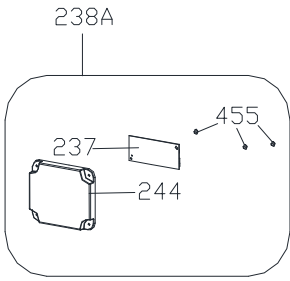

INVERTER
(OPTIONAL)

