

OPTIONAL  
WITH TOP PANEL LED

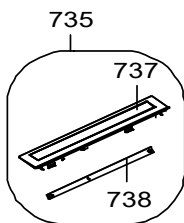

OPTIONAL  
WITH SIDE PANEL LED

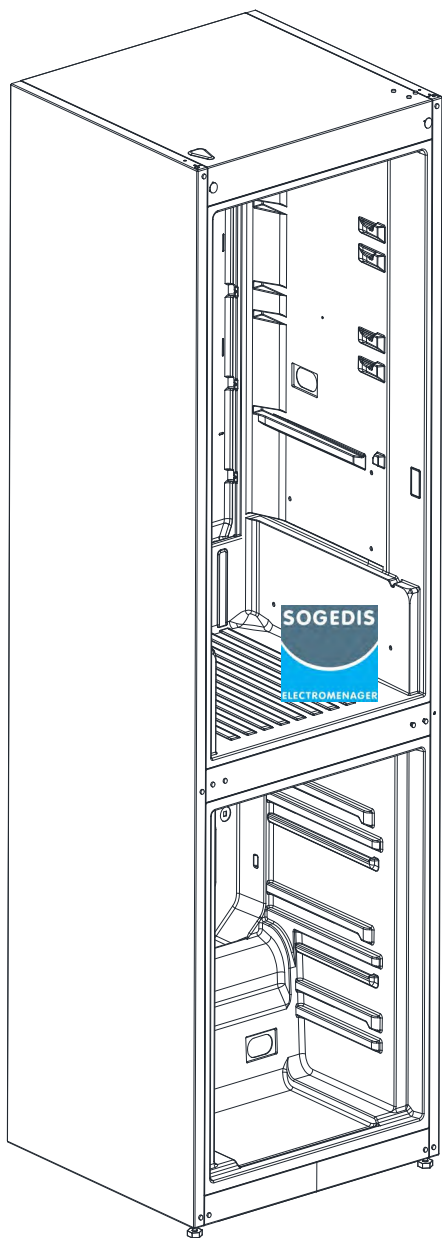
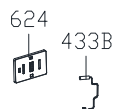
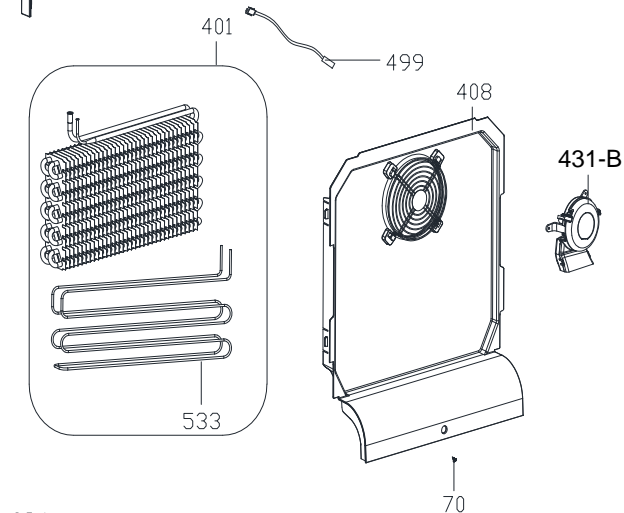
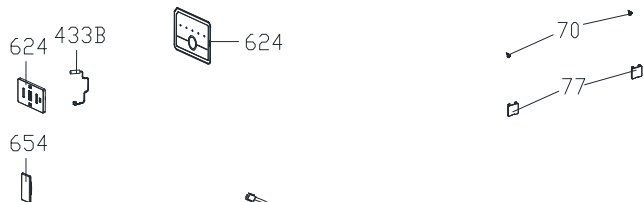
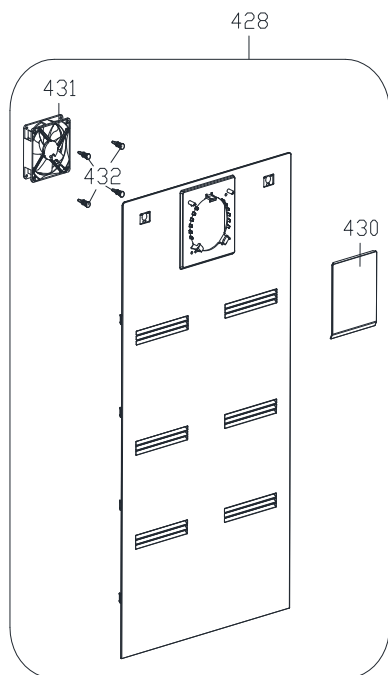
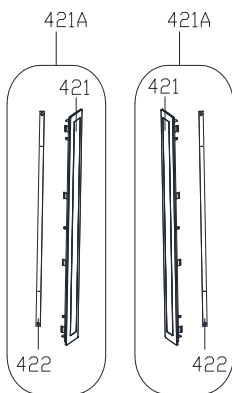

154

189

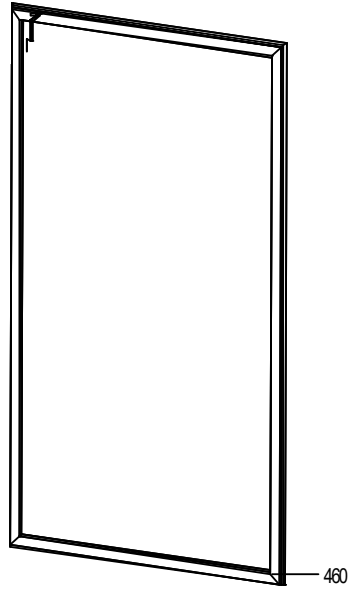
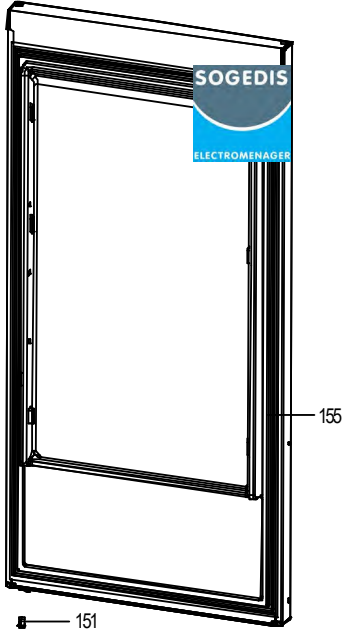
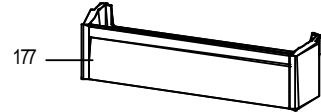
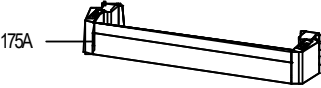
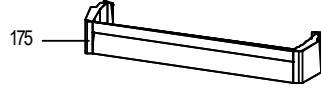

- 151
- 173
- 171

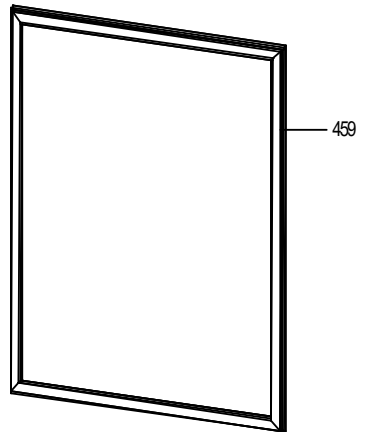
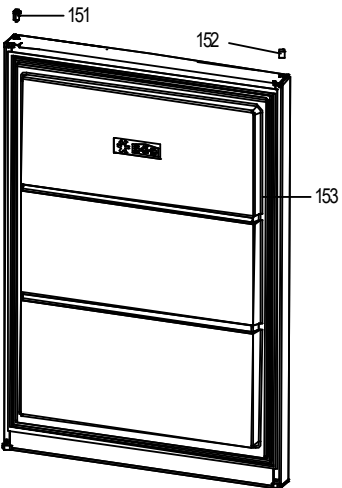

- 174B
- 187
- 174
- 463

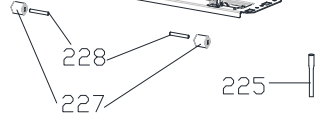
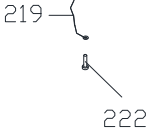
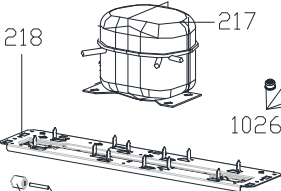
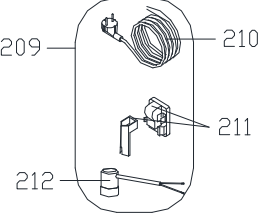
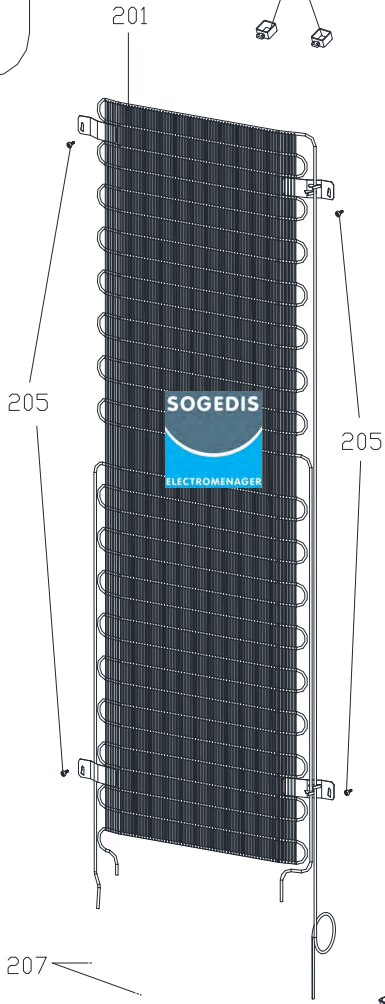
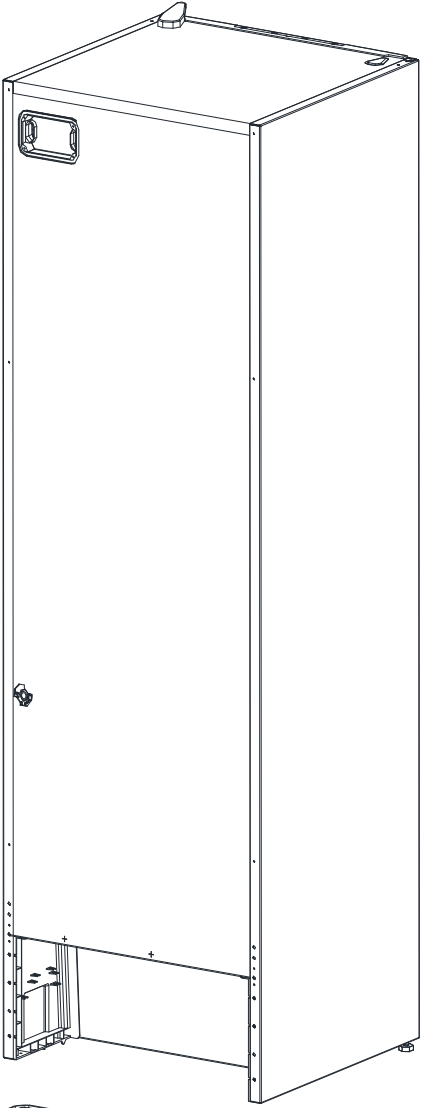
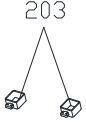
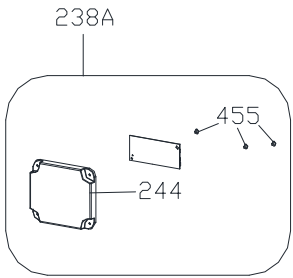

INVERTER  
(OPTIONAL)

